

Flagpoles • Flagpole Components



JANUARY 2019 EDITION



Flagpole Designer 2.0

Create millions of individual Flagpole Specification Drawings to match the requirements of any project. *Just a click away!*

"Perfect for Architects, Designers, and Specifiers of Flagpoles."

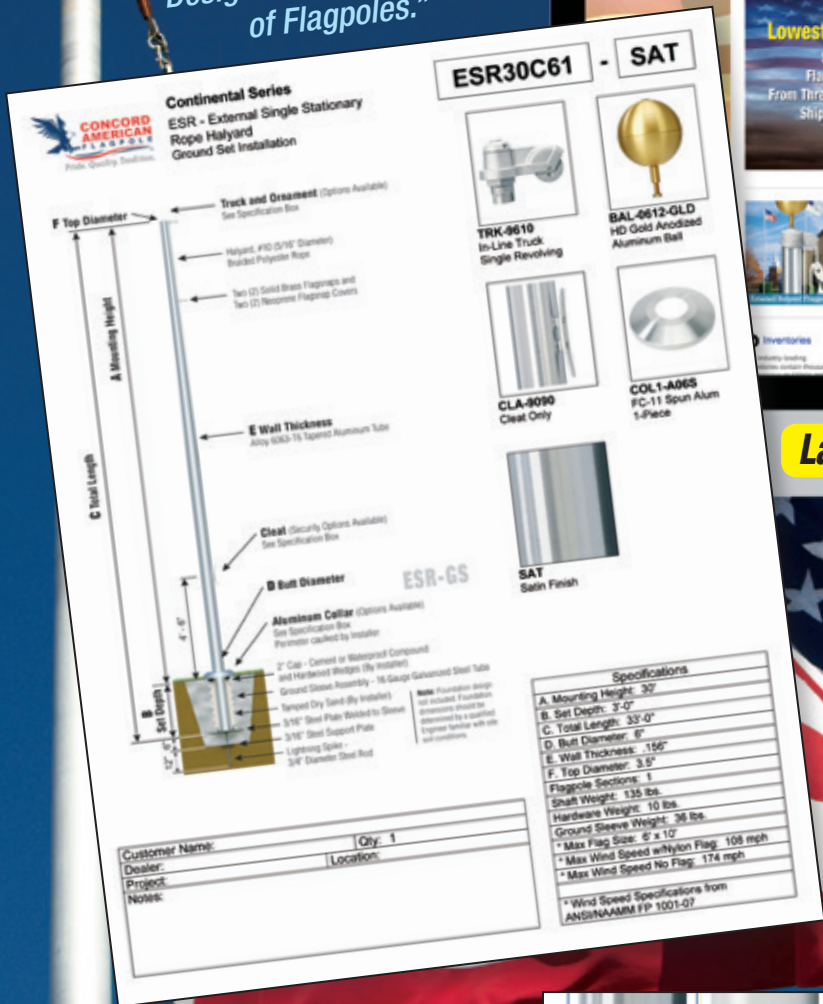
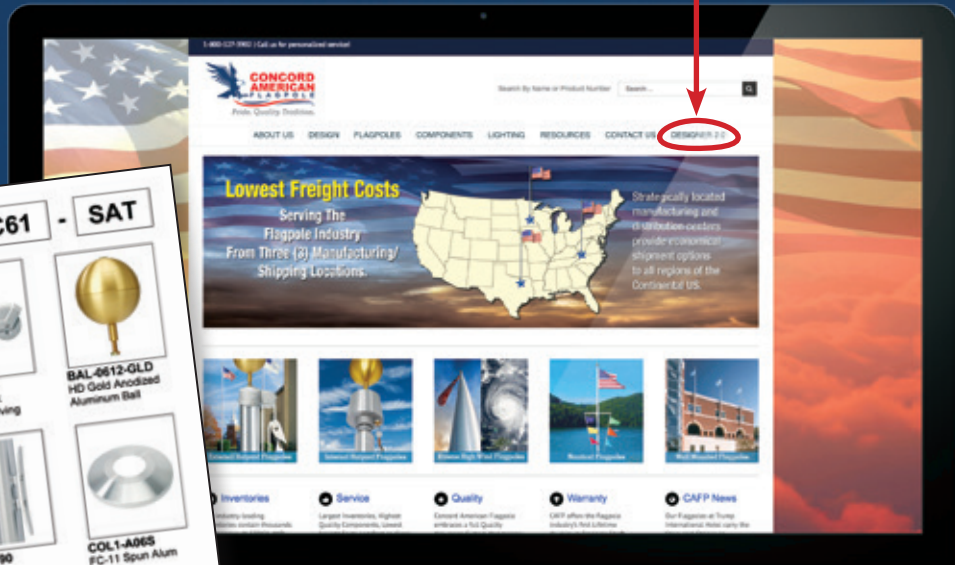

Launching February 1st, 2019

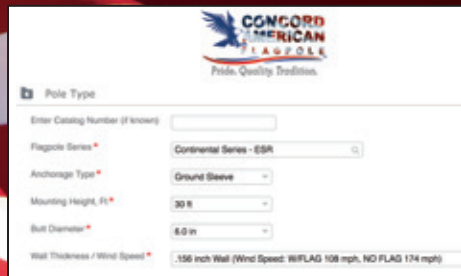

1. Choose Flagpole Specifications

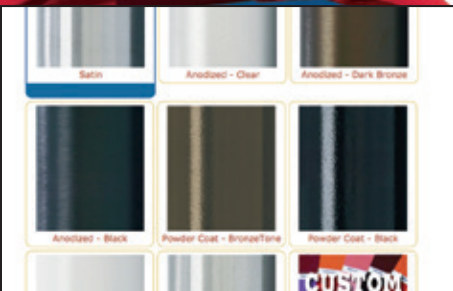

2. Choose Flagpole Finish



3. Choose Truck



4. Choose Ornament



5. Choose Collar

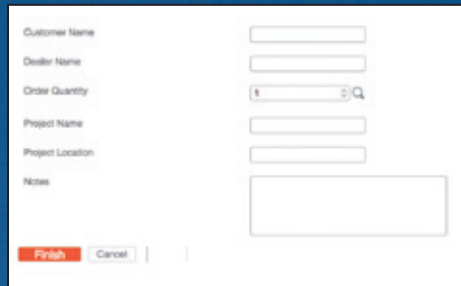

6. Assign Project Details



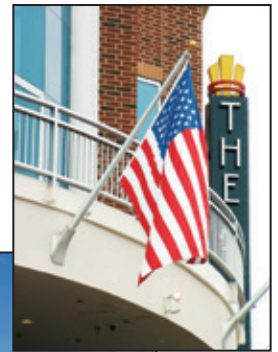
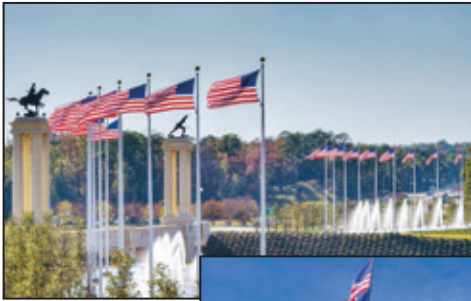

Contents

DESCRIPTION	PAGE
History	4
Flagpole Specialist	5
Flagpole Inventory	6-7
Design - Halyard Options	8-9
Design - Shaft Descriptions	10
Design - Flagpole Options	11
Design - Custom and Specials	12
Design - Miscellaneous	13
Design - Flagpole Foundations & Height	14
Flagpole Windspeeds	15
Design - Finish Options	16
Design - Part Numbers	17
Estate - ESS External Single Stationary	18-19
Continental - ESR External Single Revolving	20-21
Extreme - XESR External Single Revolving	22-23
Monarch - ICC Internal Cam Cleat	24-25
Sentry - ISC Internal Cam Cleat - Reinforced	26-27
Sentry II - IRC Internal Cam Cleat - Reinforced	28-29
Titan - IWW Internal With Winch	30-31
Sovereignty - ISW Internal Winch - Reinforced	32-33
Independence - IRW Internal Winch - Reinforced	34-35
Extreme - XIWW Internal With Winch	36-37
Extreme - XIRW Internal With Winch - Reinforced	38-39
Nautical - NSM Single Mast	40-41
Nautical - NDM Double Mast	42-43
Outrigger - OSS Outrigger Single Stationary	44-45
Vertical Wall Mount - VSS/VTS/VTR	46-47
Internal Vertical Wall Mount - VIC Cam Cleat	48

DESCRIPTION	PAGE
Internal Vertical Wall Mount - VIW Winch	49
Flagpole Kits / Telescoping Flagpoles	50-53
Flags	54-55
Flagpole Balls	56-58
Finials	58
Eagles	59
Trucks - External	60-62
Ball Trucks - External	63
Trucks - Internal	64-65
Ball Trucks - Internal	66
Miscellaneous Trucks	67
Halyard - External Rope	68-69
Flag Arrangements	70
Halyard - Internal Wire	71
Flagsnaps	72
Counterweights	73
Retainer Ring Assemblies	73
Cleats	74
Halyard Security	75
Cam Cleats, Winches and Locks	76
Ground Sleeves	77
Collars	78-79
Internal Halyard Accessories	80
Miscellaneous Accessories	81
Flagpole Lighting	82-89
Flagpole Windspeed Chart	90-92
Terms and Conditions	93-95
Lifetime Warranty	96-97



Concord American Flagpole has a proud history that brings over 70 years of experience to the aluminum flagpole industry. As an industry-leading manufacturer and distributor of Flagpole and Flagpole Components, we are extremely proud to offer the best flagpole value, the highest level of professional customer service and continued innovation to industry professionals worldwide.

Whether your project requires a single flagpole in a residential or business setting, flagpoles in front of memorials, parks, or corporate and government buildings or elaborate multiple flagpole designs, Concord American Flagpole has the technical competence, quality and commitment to service to ensure your success.

Asked for by name by contractors and architects, Concord American Flagpole's reputation for excellence makes us one of the most recognized...AND SPECIFIED... names in the Flagpole industry.

Engineering

Concord American Flagpole Engineering has a proud history of dedicated involvement in the research that shaped the aluminum flagpole industry. Decades of testing in our in-house R&D labs, active participation in numerous national industry organizations, and adoption of modern solid modeling techniques assure quality product designs that are guaranteed to meet or exceed current National Association of Architectural Metal Manufacturers (NAAMM) specifications. Our passion for excellence in innovation and product quality has created many products and concepts that are industry-accepted standards, with our advanced technical skill and in-depth aluminum metallurgical knowledge providing the solid foundation for the industry's leading Lifetime Flagpole Shaft Warranty (See Page 90).



Manufacturing

Our manufacturing expertise is derived by combining the most advanced, state-of-the-art aluminum manufacturing technologies with dedicated and knowledgeable employees. Our campuses comprise over 375,000 sq. ft. of manufacturing, distribution, and administrative offices. We are dedicated to the principles of Lean Manufacturing, joining a continuous improvement process with experienced scheduling, purchasing, production, quality control, shipping and customer service specialists.

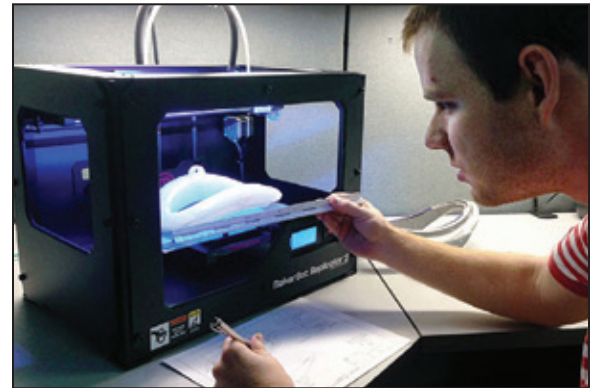

Quality Products

Concord American Flagpole embraces a full Quality Assurance System that begins with exacting raw material specifications. Aluminum shafts are constructed of 6063-T6 temper aluminum alloy with a tensile strength not less than 30,000 psi and a yield point of 25,000 psi. All shafts conform to ASTM B221. In addition, all component parts follow a strict standard inspection process, ensuring a level of quality available only with Concord American Flagpole.



*Expert Engineering Design,
World-Class Manufacturing
Capabilities and an emphasis
on Quality Control define
Concord American Flagpole.*

Flagpole Inventory

Largest Inventories

Concord American Flagpole's industry-leading inventories contain thousands of Flagpoles ***IN STOCK AND READY FOR IMMEDIATE SHIPMENT***. Inventories include our most popular 15' to 80' Internal and External Halyard systems in a variety of Satin, Anodized and Powder Coat finishes.

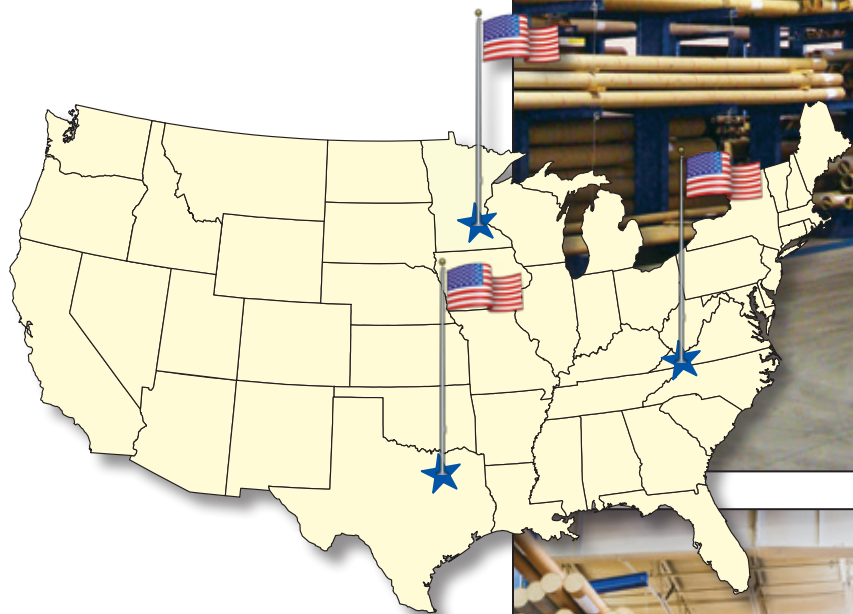

Lowest Freight Costs

Three strategically located manufacturing and distribution centers provide economical shipment options to all regions of the continental US. Options include LTL, Fed-Ex, UPS, USPS and dedicated carriers, providing the ***LOWEST COST*** shipping option for every project.



Component Inventory

Expansive Inventories of Quality Flagpole Components... Patented Balls, Ornaments, Trucks, Halyards, Flagnaps, Flags, Patented Counterweights, Retainer Ring Assemblies, Cleats, Winches, Collars, Ground Sleeves and Accessories...are available for immediate shipment.



Raw Material Inventory

Our unique role as a Manufacturing Distributor allows our extensive raw material inventories to be immediately pulled into the manufacturing process.



Integrated Supply Chain

Under the ownership and leadership of Dyson-Kissner-Moran (DKM), Concord American Flagpole is the industry's only integrated flagpole manufacturer.

This integration provides...

- Supply Chain Ownership
- The Highest Quality Aluminum Shafts
- Unparalleled Engineering and R & D
- Scale and Leverage in Both Manufacturing and Shipping



Tri-City Extrusion

A leading aluminum extruder located only 20 miles from our Virginia campus.



An industry leader in aluminum products for the Light Pole Industry.



Flagpole Design - Halyard Options

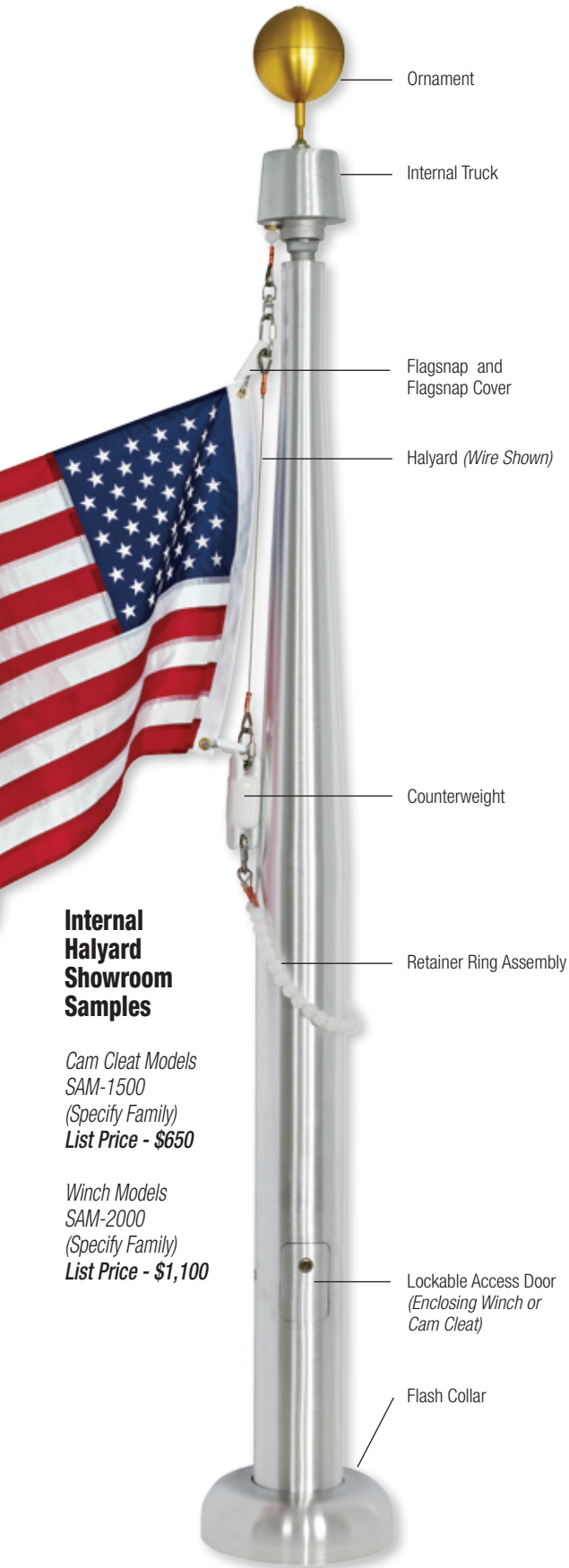

Internal Halyard Showroom Samples

Cam Cleat Models
SAM-1500
(Specify Family)
List Price - \$650

Winch Models
SAM-2000
(Specify Family)
List Price - \$1,100

A major consideration in flagpole design is the placement of the Halyard used to raise and lower the flag. Options include **Internal Halyard Systems** which enclose the Halyard behind the security of a lockable access door and **External Halyard Systems** which place the Rope Halyard on the outside of the flagpole.

Internal Halyard Systems

Winch vs. Cam Cleat

Concord American Flagpole offers Internal Halyard designs that are specially designed for the rigorous demands of outdoor flagpole systems. Winch Systems incorporate Wire Halyard with a gearless Winch and Winch Handle. Cam Cleat Systems utilize Rope Halyard in a heavy-duty cam action cleat.

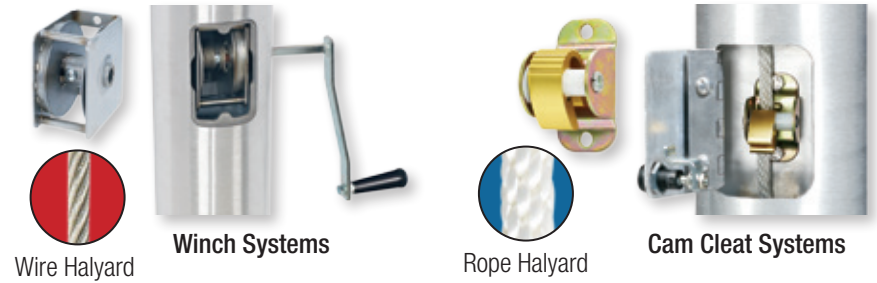

Internal Revolving Trucks vs. Internal Stationary Trucks

Internal Trucks sit at the top of the flagpole, providing an enclosed pulley system for the Wire or Rope Halyard. Options include Stationary Trucks, which are fixed and will not rotate, and Revolving Trucks, which rotate the flag with the wind.

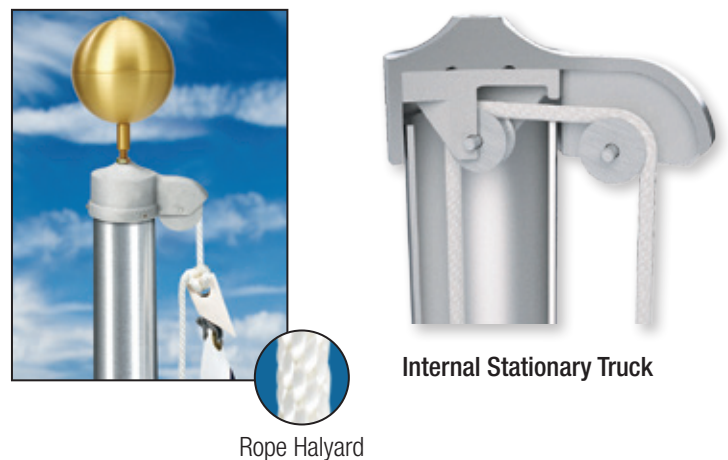
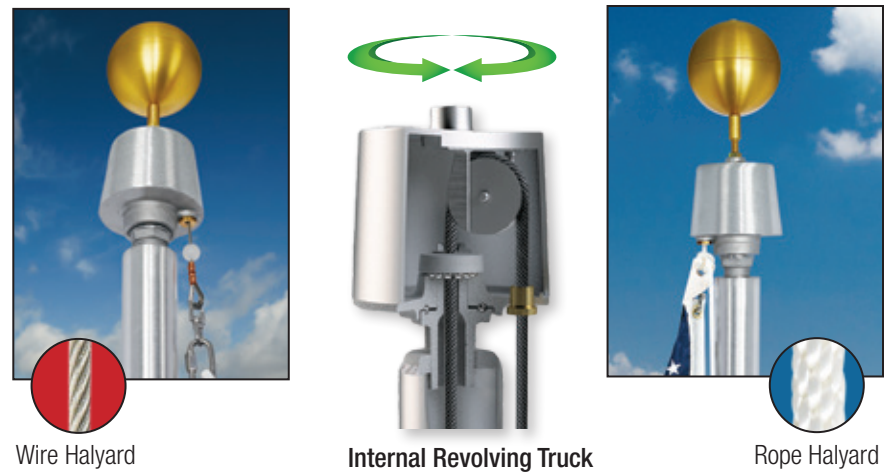

External Halyard Systems

External Halyard Systems utilize flagpole Trucks with an exposed Pulley, Rope Halyard and Flagpole Cleat. Truck options include Single Stationary, Single Revolving and Double Revolving.



Rope Halyard



External Stationary Truck



Rope Halyard



External Single Revolving Truck



Rope Halyard



External Double Revolving Truck

The External Double Revolving Truck is available as an option on all External Halyard flagpoles.



External Halyard Showroom Samples

*External Models
SAM-1000
(Specify Family)
List Price - \$650*

Flagpole Design Shaft Descriptions and Options

See Page 17 For Additional Information on Part Number Descriptions.

Mounting Height

The Mounting Height of flagpoles offered by Concord American Flagpole refers to the exposed height above grade and is measured to the top of the of the flagpole shaft.* When truck and ornaments are added, overall height can be greater by 1'-2', which can be relevant in areas with height ordinances. Upon request and at no additional charge, Mounting Heights can be shortened to achieve the desired overall height.

*NOTE: See 25' Mounting Height Exception.

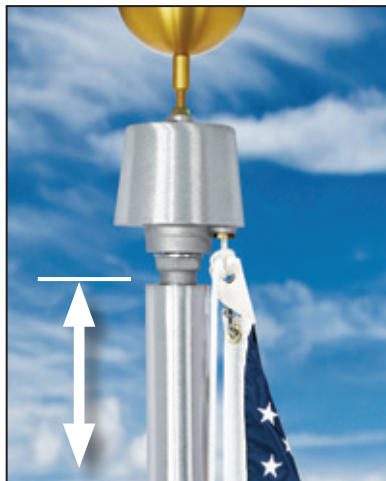

Mounting Height

25' Mounting Height Exception

Standard Ground Set Flagpoles offered in 25' Mounting Heights are manufactured in a single piece with an overall length of 26'-6". Below grade 2'-6" will be inserted into the Ground Sleeve. When the truck and finial are attached, the nominal height of the completed flagpole will be 25'. This industry accepted standard allows shipping in a pup trailer at a significant freight savings. Full 27'-6" shafts are available upon request.

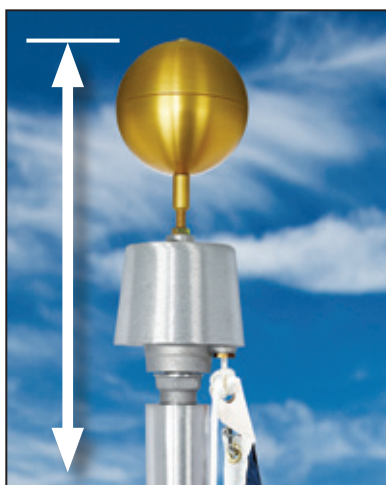

25' Nominal Mounting Height

Top Diameter and Butt Diameter

The Top Diameter is the circumference of the tapered flagpole measured at the very top of the shaft. Butt Diameter is the circumference of the flagpole in inches measured at the base of the shaft.



Top Diameter



Butt Diameter

Single & Multi-Piece Flagpole Shafts

Concord American Flagpole offers flagpoles in both single and multi-piece designs. Single piece flagpoles are offered in Mounting Heights up to 40' (44' overall length), combining ease of installation with superior aesthetics. 30'-40' flagpoles are also available in a 2-Piece option, providing the perfect solution when freight costs or jobsite locations are a deciding factor. Flagpoles 45' and larger will contain multiple piece shafts based on Mounting Height. Sections can be easily field assembled without any loss of structural integrity, leaving only a hairline joint to indicate that the shaft is not a single piece flagpole.

Wall Thickness

Wall Thickness of Concord American Flagpoles are measured in inches, with Commercial flagpoles varying from .125" to .375".



Ball Truck

A Concord American Flagpole exclusive, the Ball Truck replaces the traditional truck and ball finial by combining the function of the truck assembly with the ornamental features of a ball finial. Available in both Internal and External options, these heavy-duty, sealed bearing designs offer Architects, Specifiers and Project Owners a unique and durable truck assembly option. See Pages 63 and 66 for additional information.



Ball Truck
Replaces Traditional Truck and Finial Design

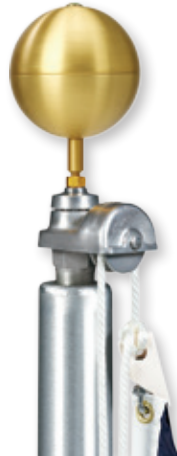

Traditional Truck and Finial Design

Ornaments

Concord American Flagpole's offering of ornaments is unequalled in the industry for both quality and selection. From our patented heavy-duty Flagpole Ball, a standard on all of our commercial flagpoles, to specialty Balls, Finials, and Eagles. Our Ornaments deliver both aesthetics and unmatched reliability, providing the perfect finishing touch to any flagpole. See Pages 56-59 for additional information.



Collar Options

Unlike many competitors, all commercial flagpoles from Concord American Flagpole include a 1-Piece Aluminum Collar as a standard. 1-Piece and 2-Piece Collars in Spun Aluminum and our industry-exclusive, 1/4" thick heavy-duty Cast Aluminum designs are available for upgrade and replacement options. See Pages 78-79 for additional information.

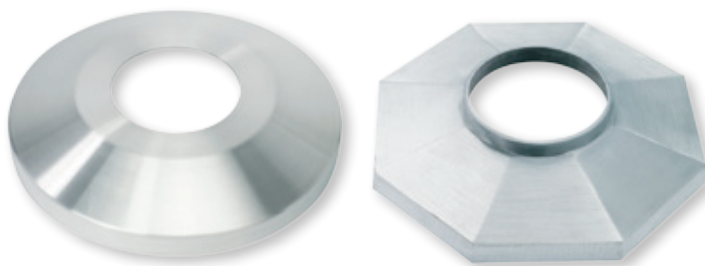

Spun and Cast Aluminum Designs



1-Piece and 2-Piece Options

Halyard Security

Cleat Cover Assemblies, Halyard Cover Assemblies, and Halyard Security Kits (combining the Cleat and Halyard Covers) provide tamper resistant security for External Halyard flagpoles. See Page 75 for additional information.



100' Flagpole

IRW Independence Series Internal Reinforced with Winch - Wire Halyard
See Page 35

Concord American Flagpole's Expert Engineering Design and World-Class Manufacturing Capabilities have led to the development of another industry first... a 100' Aluminum Flagpole* in a 12" Butt Diameter.

The advantages of aluminum when compared to Steel alternatives are substantial. Aluminum is Corrosion Resistant, Lightweight, and provides Lower Overall Cost of Ownership. Additionally, our 12" Butt Diameter Design significantly lowers installation costs when compared to competitor's 16"+ Butt Diameter Aluminum Flagpoles.

Standard Specifications

- 12" Butt Diameter, .500" Wall Thickness
- Heavy-Duty Custom 24" Ball Truck with Stainless Steel Spindle
- 44" Extra-Large Flying Eagle
- Complete Internal Wire Halyard Cable Assembly with Heavy-Duty Flag Arrangement (20' x 30')



24" Heavy-Duty Internal Ball Truck and 44" Extra Large Flying Eagle are Standard on 100' Flagpoles.

**100'
Nominal
Height
To Top
Of Eagle**



Custom and Specials Capabilities

Long recognized as a leader in innovative design, Concord American Flagpole's unique role within an integrated supply chain provides unsurpassed Engineering and Manufacturing capabilities for projects with unique and custom specifications. Our abilities are almost limitless.

- Banner Poles
- Flagpoles Incorporating Decorative Bases
- Entasis Tapered Flagpoles
- Mega Truck Applications (See Page 62)
- Oversized Flagpole Balls and Eagles (See Pages 57 & 59)
- Hinged Flagpoles

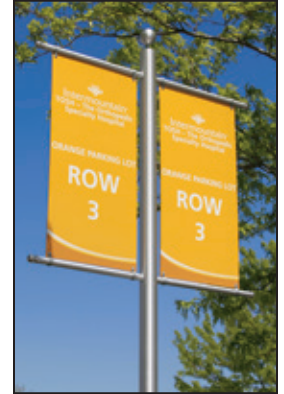

We deliver custom solutions to design professionals and project owners looking for that truly custom design.



Multiple Decorative Base Design Options Available



Cone Tapered and Entasis Tapered Flagpoles

Concord American Flagpole's standard aluminum flagpoles are designed and manufactured in a Cone Taper. This design consists of a lower, non-tapered portion of the flagpole (*length varies by flagpole height*) followed by a straight taper which extends to the top of the shaft.

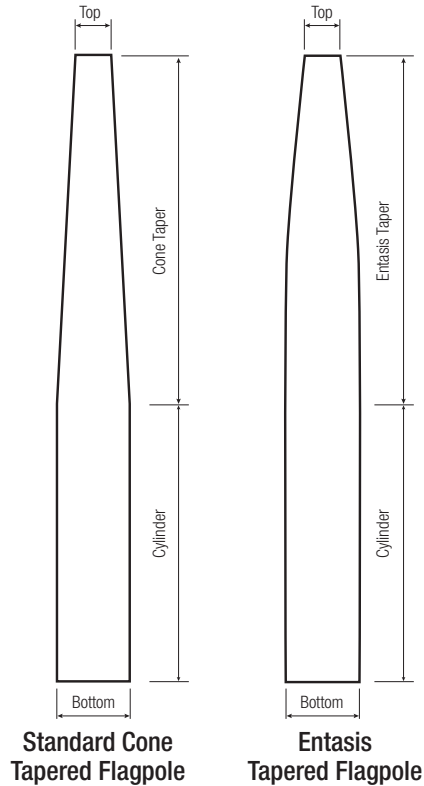

Some schools of architecture hold that a building column...or a flagpole...with a standard conical taper might appear to curve inward when viewed against the light of the sky. To counteract this illusion, early architects devised the technique of curving the taper gently outward to create a pleasing and more nearly perfect appearance. This taper is commonly referred to as an **Entasis Taper**, and is most widely recognized for its use on columns found on the Parthenon. An *Entasis Taper* is available in all Concord American Flagpole standard flagpole designs. Contact Customer Service for additional information.



Internal Halyard Winch System Diagram

The diagram below identifies the components used in a Wire Cable Based Internal Halyard Flagpole. See Pages 70-71 for more information on Wire Cable Based Internal Halyard components. **Note:** Rope Based Internal Halyard Flagpoles do not require Cable Assemblies and Flag Arrangements. See Page 69 for more information on Rope Based Internal Halyard components.

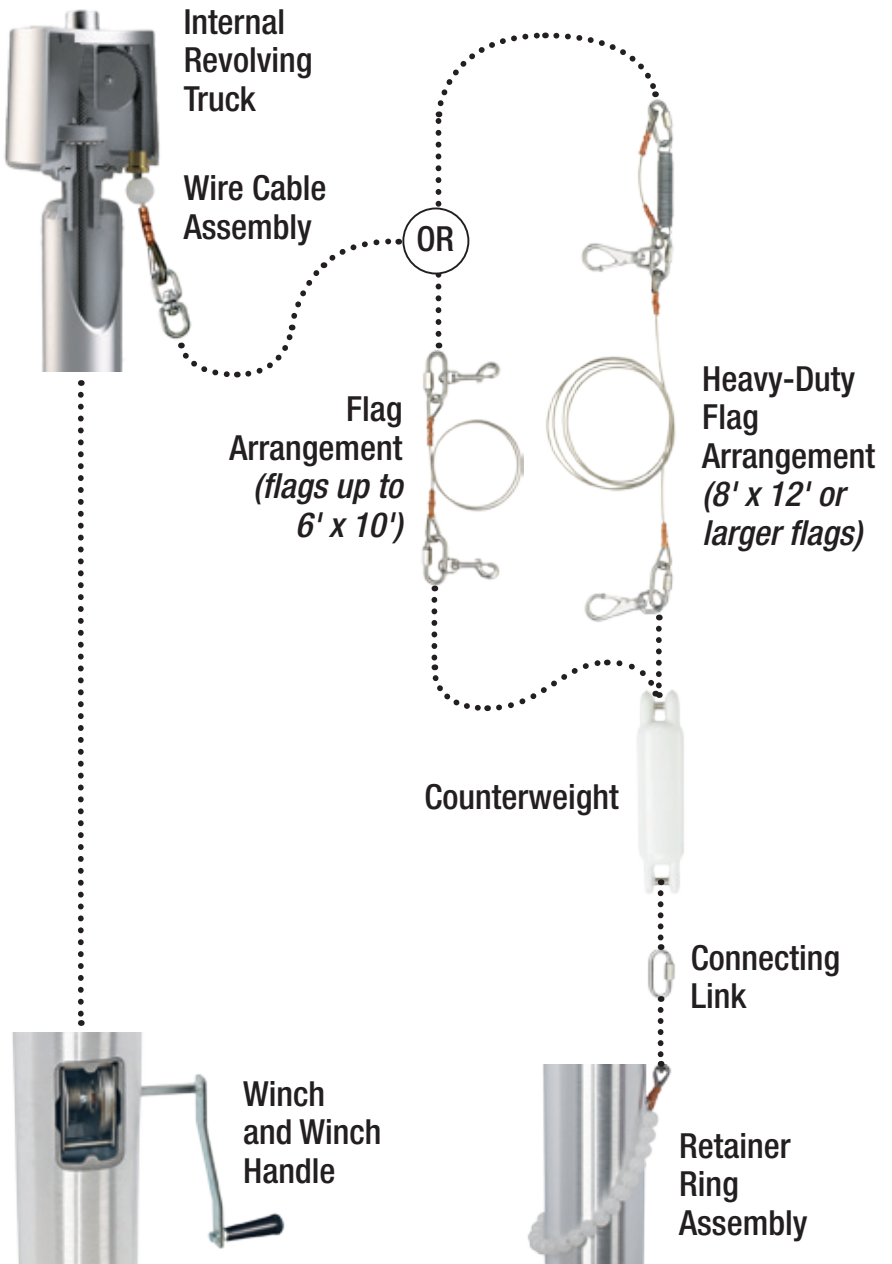

Architectural Specification Assistance

Concord American Flagpole offers a broad range of tapered aluminum flagpoles that are included in virtually all architectural specification guides. Written specifications and specification drawings can be downloaded online at www.concordamericanflagpole.com. Should you need assistance with the selection of flagpoles for a specific application, please contact Customer Service.



Designing Your Flagpole – Foundation Options

Installation methods available to securely and permanently mount the flagpole include Ground Set and Shoe Base options.

Ground Set

Ground Set installations are the strongest and most common form of flagpole installation. They require burial of the flagpole shaft in a concrete foundation to a depth equal to 10% of the mounting height.

All standard Flagpoles listed in this catalog are designed for Ground Set foundations. Each flagpole is shipped at 10% over listed Mounting Height. (See Page 10 for 25' mounting height exception.)

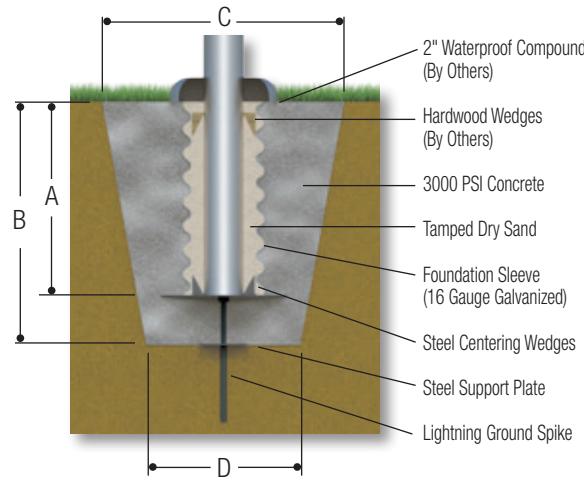

NAAMM's Metal Flagpole Manual offers basic suggestions on foundation measurements in firm, dry soil only using dry tamped sand and 3000 PSI concrete. Soil conditions vary by site. Exact foundation requirements should be verified by a Structural Engineer with knowledge of soil conditions in your locality.

EXPOSED MOUNTING HEIGHT	Ground Set			
	A	B	C	D
20'-0"	2'-0"	2'-6"	30"	24"
25'-0"	2'-6"	3'-0"	36"	24"
30'-0"	3'-0"	3'-6"	36"	24"
35'-0"	3'-6"	4'-0"	36"	30"
40'-0"	4'-0"	4'-6"	45"	36"
45'-0"	4'-6"	5'-0"	45"	36"
50'-0"	5'-0"	5'-6"	50"	42"
60'-0"	6'-0"	6'-6"	60"	48"
70'-0"	7'-0"	7'-6"	60"	48"
80'-0"	8'-0"	8'-6"	72"	48"

Shoe Base

Shoe Base installations are typically used when an above ground installation is required.

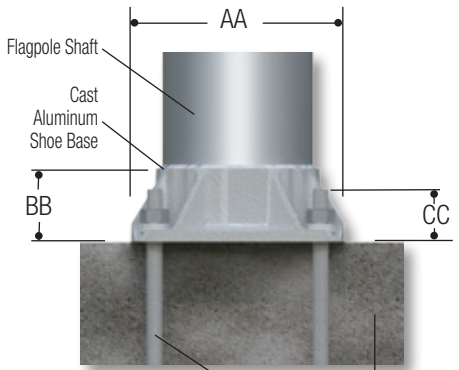

Four galvanized Steel Anchor Bolts (55,000 PSI Minimum Yield). 3000 PSI Concrete

All Shoe Base Flagpoles are heat treated after weld to T-6 temper.

Shoe Base

BUTT DIAMETER	AA BASE SQUARE	BB BASE HEIGHT	CC BOLT PROJECTION	BOLT DIAMETER	BOLT CIRCLE DIAMETER	LIST PRICE ADDER
4"	7-1/2"	3"	2"	3/4"	6-1/2" - 8"	\$210
5"	7-1/2"	3"	2"	3/4"	7 1/2"-8"	\$210
6"	9-3/4"	3-1/2"	2-3/4"	1"	9"-10"	\$260
7"	10-1/2"	3-11/16"	2-3/4"	1"	10"-11"	\$260
8"	11-1/4"	3-15/16"	2-3/4"	1"	11"-12"	\$260
10" UP TO .250	14"	4-7/8"	3-1/4"	1"	14"-15"	\$520
10" .312 & LARGER	14"	4-7/8"	3-1/4"	1-1/4"	14"-15"	\$520
12"	17"	8"	3-3/4"	1-1/4"	16"-18"	\$1,035

All Flagpoles listed in this catalog with a 4"+ Butt Diameter can be provided in a Shoe Base Installation option. List price of a Shoe Base Flagpole can be obtained by adding the appropriate List Price Shoe Base Adder to the List Price of the flagpole.

Contact Concord American Flagpole Customer Service for Wind Speed information for your particular design.

Designing Your Flagpole – Flagpole Height

The next consideration in choosing your flagpole design is to determine the mounting height. This can be specified solely on the required aesthetics of the particular job, or can be determined by the size of the flag wished to be flown.

The National Association of Architectural Metal Manufacturers (NAAMM) publishes the following criteria for determining the maximum flag size for each flagpole height.

Ground Set		Wall Mounted		Outrigger	
FLAGPOLE HEIGHT	FLAG SIZE	FLAGPOLE HEIGHT	FLAG SIZE	FLAGPOLE HEIGHT	FLAG SIZE
15'	3' x 5'	12' to 15'	4' x 6'	8'	3' x 5'
20'	4' x 6'	20' to 25'	5' x 8'	10' to 12'	4' x 6'
25'	5' x 8'	30' to 35'	6' x 10'	13' to 16'	5' x 8'
30'	6' x 10'	40' to 45'	8' x 12'	17' to 23'	6' x 10'
35'	6' x 10'				
40'	8' x 12'				
45'	8' x 12'				
50'	10' x 15'				
60'	12' x 18'				
70'	12' x 18'				
80'	15' x 25'				

Safety Note: Extreme care must be exercised when installing flagpoles near overhead power lines or when digging in the vicinity of buried utilities.

Caution: During installation, extreme care should be taken to insure that all components are securely attached.

Flagpole Specifications - Wind Speed

With the height of the flagpole determined, choosing the correct flagpole design next requires the knowledge of the Wind Loads to which the flagpole will be subjected. Concord American Flagpole Engineers, working with specifications contained in The National Association of Architectural Metal Manufacturers' (NAAMM) *Guide Specifications For Design Of Metal Flagpoles (ANSI/NAAMM FP 1001-07)*, have determined the Maximum Wind Speed for both Nylon Flagged and Unflagged flagpoles using Ground Set Installations.

STD. FLAG SIZE	MAX WIND SPEED WITH NYLON FLAG	MAX WIND SPEED NO FLAG
4' x 6'	109	147
4' x 6'	136	229
4' x 6'	160	262
4' x 6'	182	

Sample Wind Speed Chart

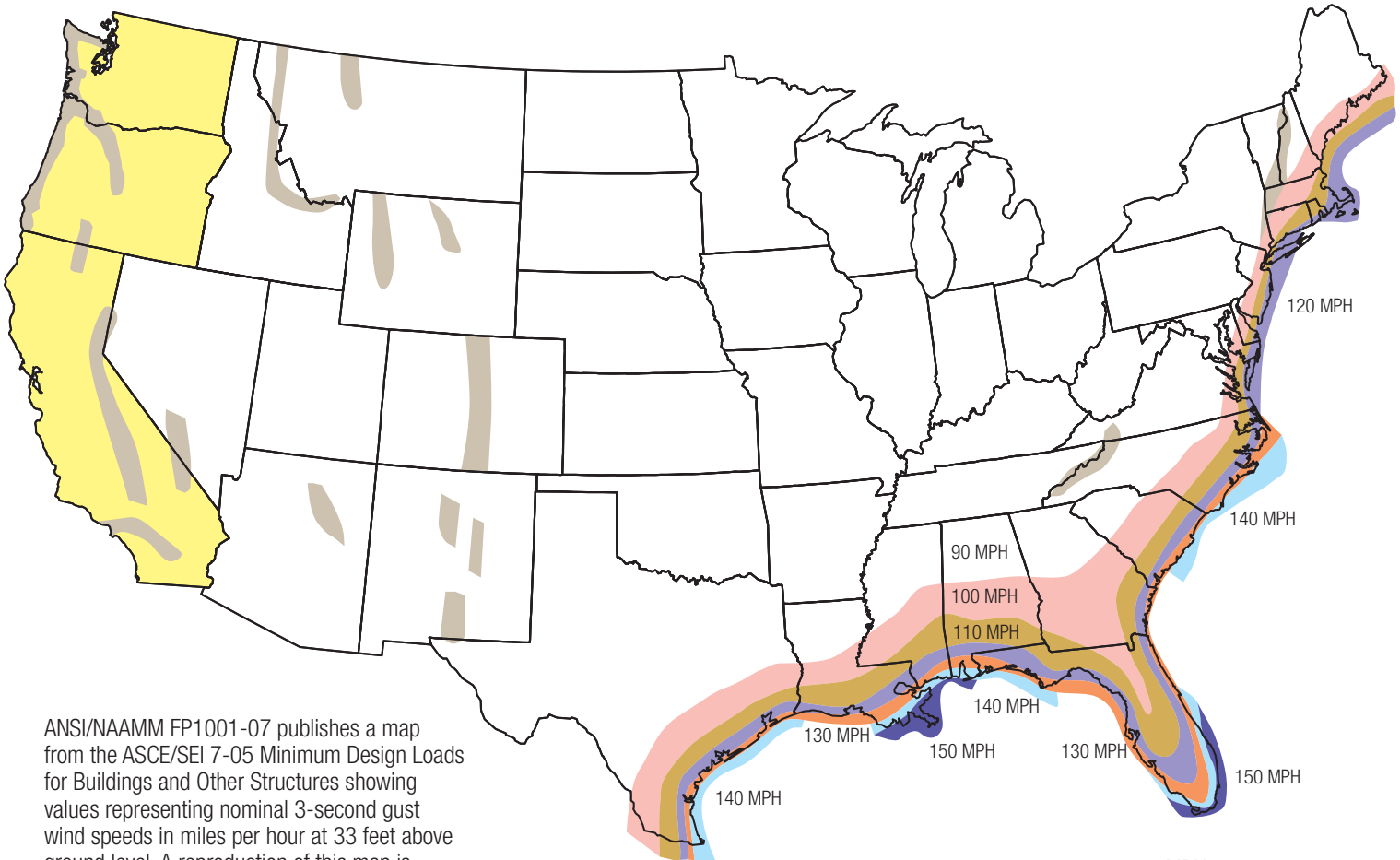

ANSI/NAAMM FP1001-07 publishes a map from the ASCE/SEI 7-05 Minimum Design Loads for Buildings and Other Structures showing values representing nominal 3-second gust wind speeds in miles per hour at 33 feet above ground level. A reproduction of this map is provided and should be used to specify the proper flagpole for your application. Please note that Special Wind Zone Areas, including but not limited to mountainous terrain, gorges, and ocean promontories, should be examined for unusual wind conditions.

Wind Speeds - Other Regions

LOCATION	MPH	(M/S)
Hawaii	105	(47)
Puerto Rico	145	(65)
Guam	170	(76)
Virgin Islands	145	(65)
American Samoa	125	(56)
Alaska*	90-130	(40-58)

- 85 MPH
- 90 MPH
- 100 MPH
- 110 MPH
- 120 MPH
- 130 MPH
- 140 MPH
- 150 MPH
- Special Wind Region

All Wind Speeds listed in Flagpole Product Tables are for Ground Set Installations flying a Nylon flag in the NAAMM recommended size listed. See Pages 84-86 Flagpole Windspeed Charts for additional calculations for Polyester Flags, Double Nylon Flags and Flags one size smaller than the NAAMM recommended maximum size. Contact Concord American Flagpole for Wind Speed information on Shoe Base installations, exceeding the maximum NAAMM recommended flag size for flagpole height chosen, installation on rooftops, or for flying multiple flags in sizes or materials not listed in the Chart.

Safety Note: The specification and installation of a flagpole with wind speed ratings that do not meet the maximum wind speed for the project location, or flagpoles flying flags and banners that exceed the NAAMM recommended flag size, can result in personal injury and/or property damage. Flags should always be removed from the flagpole during severe weather events.

Designing Your Flagpole – Finish Options

Concord American Flagpole is the industry's unsurpassed leader in finish options.

Satin Finish

Concord American Flagpole's aluminum flagpoles are constructed of Aluminum Alloy 6063, a marine grade alloy that exhibits extremely high resistance to corrosion.

On contact with air, Aluminum forms a resistant layer of aluminum oxide. This process naturally guards against corrosion, allowing our flagpoles to be left unfinished while ensuring a lifetime of aesthetic beauty.

Concord American Flagpole's Satin Aluminum Finish is achieved in a multi-pass, mechanical rotary sanding operation utilizing specially formulated abrasives. This attention to detail ensures a consistent, brushed aluminum finish that has become the industry's first choice for low-maintenance and enduring flagpole finishes.



SAT - Satin Aluminum Finish

Powder Coat Finish

Concord American Flagpole combines state-of-the-art, on-site Powder Coating operations with the highest quality polyester thermoset powders.

Standard Colors



BZT - BronzeTone



BLK - Black



CLR - Clear



WHT - White

Unlimited Color Options

Simply provide an RAL color number or color chip sample and Concord American Flagpole can provide the perfect Powder Coat Color for your next project.



Anodized Finish

Concord American Flagpole offers standard Anodized flagpole finishes in Clear, Dark Bronze and Black. Exacting manufacturing specifications enhance the anodizing process, ensuring Concord American Flagpole customers the optimum color and longevity in colored Anodized finishes.



ACL - Clear



ADB - Dark Bronze



ABL - Black

Flagpole Catalog Number Description

Products are identified by the Design, Exposed Mounting Height, Wall Thickness, Butt Diameter, Shaft Section, and Finish.

Custom designs are available. See Page 12 for more information.

Catalog Number Example (ESR30B51-SAT)

DESIGN	EXPOSED HEIGHT	WALL THICKNESS	BUTT DIAMETER	SHAFT SECTIONS	FINISH
ESR	30	C	6	1	SAT

ESR = External Single Revolving,
 30 = 30 foot Mounting Height,
 C = 0.156" Wall Thickness,
 6 = 6" Butt Diameter,
 1 = One-Piece Ground Set Shaft,
 SAT = Satin Brushed Aluminum Finish

Design		Height		Wall Thickness		Butt Diameter		Shaft Selections		Finish	
CODE	DESCRIPTION	CODE	LENGTH	CODE	WALL THICKNESS	CODE	BUTT DIA.	CODE	SHAFT TYPE	CODE	DESCRIPTION
ESS	External Single Stationary	10	10 foot	P	0.065 inches	B	2 inches	1	1-piece, Ground Set	SAT	Satin Aluminum
ESR	External Single Revolving	12	12 foot	B	0.125 inches	D	2.5 inches	2	2-piece, Ground Set	ACL	Anodized - Clear
EDR	External Double Revolving	15	15 foot	C	0.156 inches	3	3 inches	3	3-piece, Ground Set	ADB	Anodized - Dark Bronze
XESR	Xtreme External Single Revolving	20	20 foot	D	0.188 inches	F	3.5 inches	4	4-piece, Ground Set	ABL	Anodized - Black
ICC	Internal Cam Cleat	25	25 foot	E	0.219 inches	4	4 inches	M	1-piece, Shoe Base	BZT	Powder Coat - BronzeTone
ISC	Internal Sentry Cam Cleat	30	30 foot	F	0.250 inches	5	5 inches	N	2-piece, Shoe Base	BLK	Powder Coat - Black
IRC	Internal Reinforced with Cam Cleat	35	35 foot	G	0.312 inches	H	5.5 inches	P	3-piece, Shoe Base	WHT	Powder Coat - White
IWW	Internal With Winch	40	40 foot	H	0.375 inches	6	6 inches	Q	4-piece, Shoe Base	CLR	Powder Coat - Clear
ISW	Internal Sovereignty Winch	45	45 foot	I	0.500 inches	7	7 inches			XXX	Powder Coat - (Specify)
IRW	Internal Reinforced with Winch	50	50 foot			8	8 inches				
XIWW	Xtreme Internal With Winch	55	55 foot			9	9 inches				
XIRW	Xtreme Int. Reinforced w/ Winch	60	60 foot			1	10 inches				
NSM	Nautical Single Mast	65	65 foot			2	12 inches				
NDM	Nautical Double Mast	70	70 foot								
O**	Outrigger Series (**Specify Bracket)	75	75 foot								
V**	Vertical Series (**Specify Bracket)	80	80 foot								
VIC	Vertical Internal Cam Cleat										
VIW	Vertical Internal Winch										
ATK	American Tradition Kit										
PAT	Patio Kit										



PAGE 18



PAGE 20



PAGE 22



PAGE 24



PAGE 26



PAGE 28



PAGE 30



PAGE 32



PAGE 34

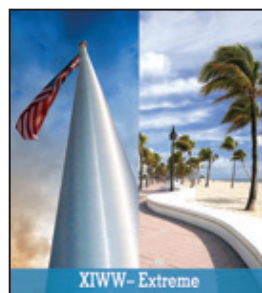

PAGE 36



PAGE 38



PAGE 40



PAGE 42



PAGE 44



PAGE 46

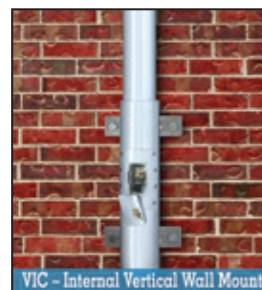

PAGE 48



PAGE 49

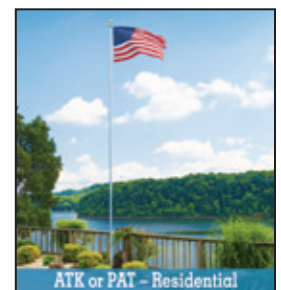

PAGE 50

Estate Series - ESS

External Single Stationary - Rope Halyard

The **Estate Series** from Concord American Flagpole provides commercial grade flagpoles that are a perfect fit for budget minded projects. Manufactured to the same quality standards as our Continental Series, our Estate Series offers flagpoles with heights from **15' to 35'** which are ideal for residential homes, small businesses and commercial complexes.

STANDARD FLAGPOLE ACCESSORIES - 3" TO 5" BUTT DIAMETERS

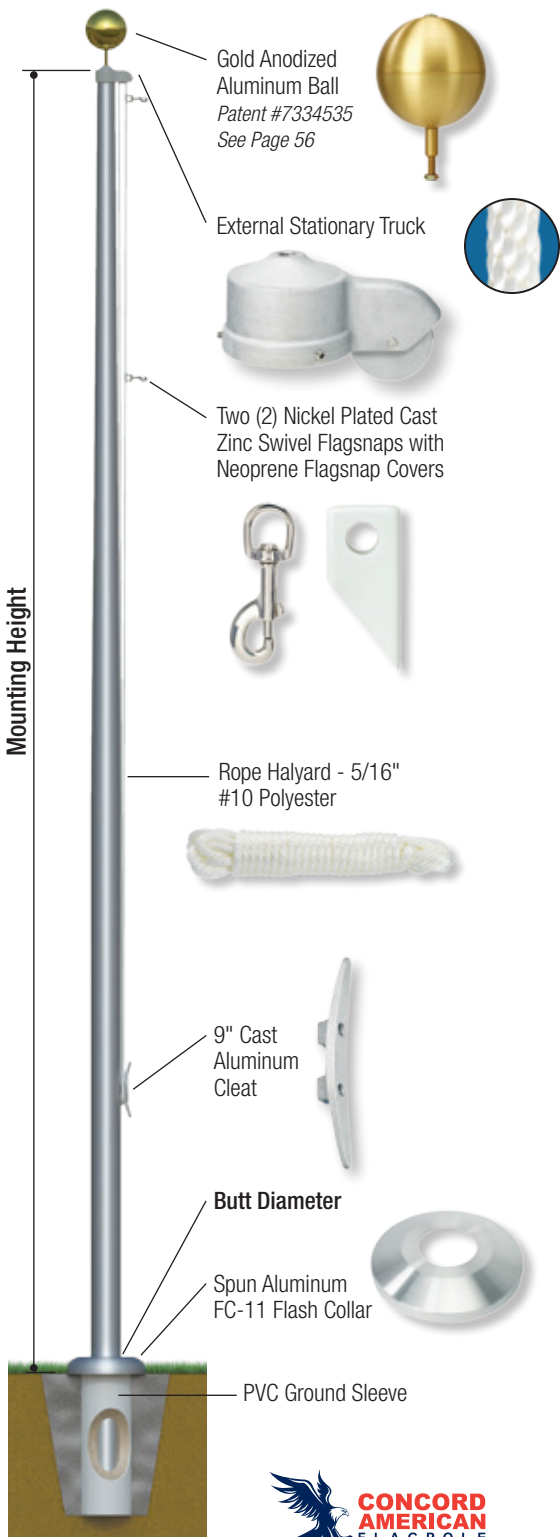

Standard Specifications

- Patented, Heavy-Duty Gold Anodized Aluminum Ball
- Cast Aluminum Single Stationary Truck Assembly with Aluminum Pulley
- Complete External Halyard Assembly
 - Rope Halyard - 5/16" #10 Polyester
 - Two (2) Nickel Plated Cast Zinc Swivel Flagsnaps
 - Two (2) Neoprene Flagsnap Covers
- 9" Cast Aluminum Cleat
- Spun Aluminum FC-11 Flash Collar
- PVC Ground Sleeve



Estate Series - ESS External Single Stationary - Rope Halyard

MTG. HGT.	BUTT DIA.	WALL THICKNESS	POLE SECTIONS	SET DEPTH	TOP DIA.	STD. FLAG SIZE	MAX WIND SPEED WITH NYLON FLAG	MAX WIND SPEED NO FLAG	CATALOG NUMBER ***SPECIFY FINISH	SATIN	CLEAR ANODIZED	DARK BRONZE OR BLACK ANODIZED	BRONZE TONE, BLACK, WHITE OR CLEAR POWDERCOAT
15'	3"	.125"	1	2'-0"	2"	3' x 5'	113	149	ESS15B31-***	\$456	\$528	\$561	\$512
20'	3"	.125"	1	2'-0"	2"	4' x 6'	83	108	ESS20B31-***	\$533	\$634	\$655	\$615
	4"	.125"	1	2'-0"	2"	4' x 6'	109	147	ESS20B41-***	\$800	\$943	\$988	\$914
	5"	.125"	1	2'-0"	3"	4' x 6'	136	229	ESS20B51-***	\$996	\$1,154	\$1,235	\$1,120
	5"	.156"	1	2'-0"	3"	4' x 6'	160	262	ESS20C51-***	\$1,108	\$1,274	\$1,348	\$1,236
	5"	.188"	1	2'-0"	3"	4' x 6'	182	287	ESS20D51-***	\$1,301	\$1,466	\$1,539	\$1,422
25'	3"	.125"	1	2'-6"	2"	5' x 8'	63	83	ESS25B31-***	\$638	\$762	\$826	\$739
	4"	.125"	1	2'-6"	2"	5' x 8'	83	106	ESS25B41-***	\$887	\$1,029	\$1,098	\$998
	5"	.125"	1	2'-6"	3"	5' x 8'	98	136	ESS25B51-***	\$1,163	\$1,378	\$1,457	\$1,336
	5"	.156"	1	2'-6"	3"	5' x 8'	111	178	ESS25C51-***	\$1,370	\$1,585	\$1,664	\$1,537
	5"	.188"	1	2'-6"	3"	5' x 8'	124	209	ESS25D51-***	\$1,727	\$1,942	\$2,021	\$1,883
30'	4"	.125"	1	3'-0"	2"	6' x 10'	66	85	ESS30B41-***	\$952	\$1,149	\$1,233	\$1,115
	4"	.125"	2	3'-0"	2"	6' x 10'	66	85	ESS30B42-***	\$1,017	\$1,214	\$1,298	\$1,178
	5"	.125"	1	3'-0"	3"	6' x 10'	78	96	ESS30B51-***	\$1,283	\$1,536	\$1,622	\$1,490
	5"	.125"	2	3'-0"	3"	6' x 10'	78	96	ESS30B52-***	\$1,397	\$1,650	\$1,736	\$1,601
	5"	.156"	1	3'-0"	3"	6' x 10'	86	112	ESS30C51-***	\$1,572	\$1,825	\$1,911	\$1,770
	5"	.156"	2	3'-0"	3"	6' x 10'	86	112	ESS30C52-***	\$1,626	\$1,879	\$1,963	\$1,822
	5"	.188"	1	3'-0"	3"	6' x 10'	94	131	ESS30D51-***	\$1,812	\$2,065	\$2,151	\$2,003
	5"	.188"	2	3'-0"	3"	6' x 10'	94	131	ESS30D52-***	\$1,866	\$2,119	\$2,204	\$2,054
35'	5"	.125"	1	3'-6"	3"	6' x 10'	66	78	ESS35B51-***	\$1,514	\$1,805	\$1,919	\$1,750
	5"	.125"	2	3'-6"	3"	6' x 10'	66	78	ESS35B52-***	\$1,609	\$1,900	\$2,015	\$1,843
	5"	.156"	1	3'-6"	3"	6' x 10'	73	87	ESS35C51-***	\$1,603	\$1,908	\$1,987	\$1,827
	5"	.156"	2	3'-6"	3"	6' x 10'	73	87	ESS35C52-***	\$1,653	\$1,944	\$2,058	\$1,885
	5"	.188"	1	3'-6"	3"	6' x 10'	79	95	ESS35D51-***	\$2,132	\$2,429	\$2,531	\$2,873
	5"	.188"	2	3'-6"	3"	6' x 10'	79	95	ESS35D52-***	\$1,973	\$2,264	\$2,377	\$2,195

*** - Finish Options

- SAT = Satin
- ACL = Anodized - Clear
- ADB = Anodized - Dark Bronze
- ABL = Anodized - Black
- BZT = Powder Coat - BronzeTone
- BLK = Powder Coat - Black
- WHT = Powder Coat - White
- CLR = Powder Coat - Clear

Quantity Discounts

- 5+ = 5%
- 8+ = 10%
- 15+ = 12%
- *Flagpoles From All Flagpole Series May Be Combined To Achieve Quantity Discounts.

ESTATE SERIES - ESS OPTIONS

Cap Mounted Style Single Revolving Truck In Lieu Of Standard Stationary Truck.



See Page 62 Add \$55

Cast Aluminum, Gold Powder Coated Stationary Ball Truck. Replaces Standard Truck and Ball Combination.



See Page 63 Add \$30

Cleat Cover (Specify Cylinder Lock or Padlock) - See Page 75.
 3"-4" Butt Diameters Add \$105
 5" Butt Diameters Add \$130



Cleat Cover Box with 5' Halyard Cover (Specify Cylinder Lock or Padlock) - See Page 75.
 3"-4" Butt Diameters Add \$200
 5" Butt Diameters Add \$250

Cast Aluminum FC-11 Collar In Lieu of Spun Collar - See Page 79.
 3"-5" Butt Diameters Add \$55



Flagpole Lighting Options are available for all Estate Series Flagpoles – See Pages 82-89.

Shoe Base Designs for Surface Mount Installations are available in 4" and 5" Estate Series – ESS Flagpoles. See Page 14.
 4"-5" Butt Diameters . . Add \$210

Continental Series - ESR

External Single Revolving - Rope Halyard

The **Continental Series** from Concord American Flagpole combines heavy-duty aluminum flagpoles in **20' to 80'** mounting heights with the highest quality hardware available to the industry today. These flagpoles meet the most stringent architectural standards and are certain to enhance the landscape of any business or industrial property.



STANDARD FLAGPOLE ACCESSORIES - 4" TO 8" BUTT DIAMETERS

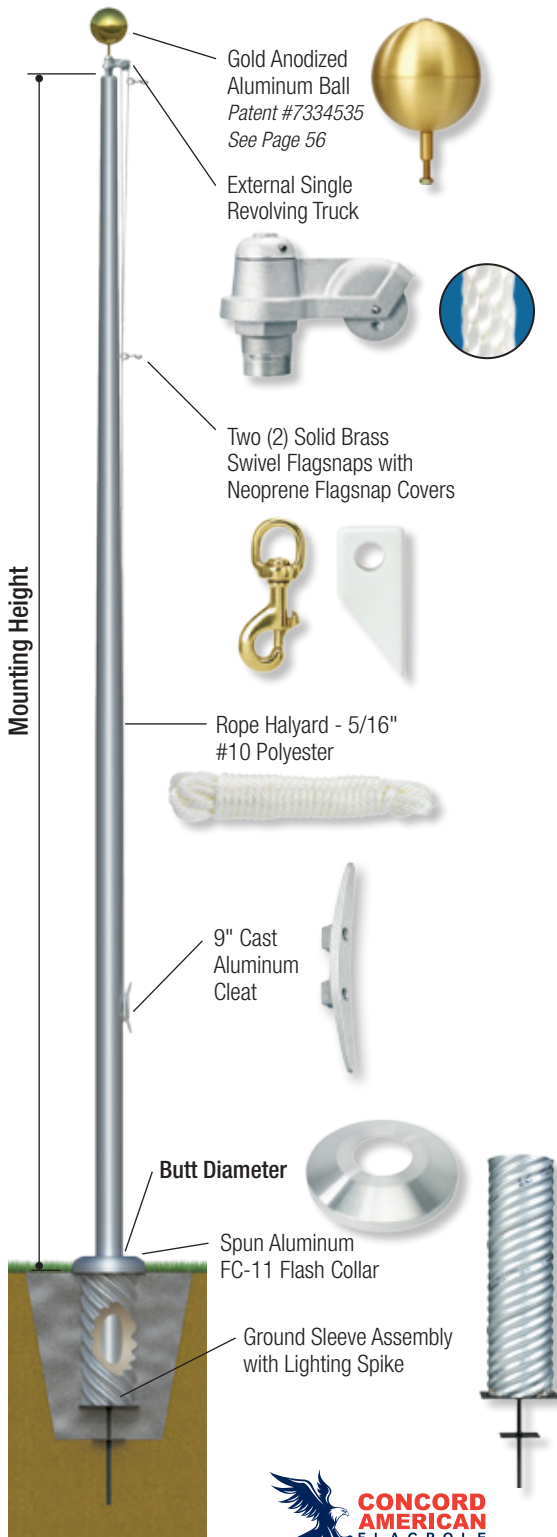

Gold Anodized Aluminum Ball
Patent #7334535
See Page 56

External Single Revolving Truck

Two (2) Solid Brass Swivel Flagnaps with Neoprene Flagnap Covers

Rope Halyard - 5/16" #10 Polyester

9" Cast Aluminum Cleat

Butt Diameter

Spun Aluminum FC-11 Flash Collar

Ground Sleeve Assembly with Lighting Spike



Shoe Base Designs for Surface Mount Installations are available with Continental Series – ESR Flagpoles. See Page 14.

- 4"-5" Butt Diameters Add \$210
- 6"-8" Butt Diameters Add \$260
- 10" Butt Diameters Add \$520
- 12" Butt Diameters Add \$1,035

Standard Specifications

- Patented, Heavy-Duty Gold Anodized Aluminum Ball
- Cast Aluminum Revolving Truck with Dual Stainless Steel Bearing Assemblies, Aluminum Pulley and Aluminum Spindle
- Complete External Halyard Assembly
 - Rope Halyard - 5/16" #10 Polyester
 - Two (2) Solid Brass Swivel Flagnaps
 - Two (2) Neoprene Flagnap Covers
- 9" Cast Aluminum Cleat
- Spun Aluminum FC-11 Flash Collar
- Galvanized 16-Gauge Corrugated Steel Ground Sleeve with Steel Grounding Spike

Standard Upgrades – 10" and 12" Butt Diameters

- Heavy-Duty Truck with Dual SEALED Bearing Assemblies
- Rope Halyard - Heavy-Duty 3/8" #12 Polyester
- Two (2) Heavy-Duty Brass Flagnaps with Covers
- Heavy-Duty 5/8" Ball Stem
- Heavy-Duty Cast Aluminum Collar

CONTINENTAL SERIES - ESR OPTIONS

Double Revolving System (Double Truck, Extra Cleat and Complete Double Halyard Assembly) – Specify EDR (External Double Revolving). See Page 61 Add \$55



Heavy-Duty Truck with Dual SEALED Bearings for 4"-8" Butt Diameter Flagpoles. See Page 61 Add \$115



Cast Aluminum, SEALED Bearings, Gold Powder Coated Ball Truck. Replaces Standard Truck and Ball Combination - See Page 63.



8" Diameter Ball/Truck Add \$135

Cleat Cover Box (Specify Cylinder Lock or Padlock). See Page 75 Add \$130



Cleat Cover Box with 5' Halyard Cover (Specify Cylinder Lock or Padlock) - See Page 75. 5"-6" Flagpole Butt Diameters . . . Add \$250
7"-12" Flagpole Butt Diameters . . . Add \$300

Cast Aluminum FC-11 Collar In Lieu of Spun Collar - See Page 79. 5"-7" Butt Diameters Add \$55
8"-12" Butt Diameters Add \$165

PVC Ground Sleeve In Lieu Of Steel Sleeve (4"- 5" Butt Diameters Only). See Page 77 Deduct (\$100)

Flagpole Lighting Options are available for all Continental Series Flagpoles – See Pages 82-89.



Continental Series - ESR External Single Revolving - Rope Halyard

MTG. HGT.	BUTT DIA.	WALL THICKNESS	POLE SECTIONS	SET DEPTH	TOP DIA.	STD. FLAG SIZE	MAX	MAX	CATALOG	SATIN	CLEAR ANODIZED	DARK BRONZE OR BLACK ANODIZED	BRONZETONE, BLACK, WHITE OR CLEAR POWDERCOAT
							WIND SPEED WITH NYLON FLAG	WIND SPEED NO FLAG	NUMBER ***SPECIFY FINISH				
20'	4"	.125"	1	2'-0"	2"	4' x 6'	109	147	ESR20B41-***	\$895	\$1,038	\$1,085	\$1,007
	5"	.125"	1	2'-0"	3"	4' x 6'	136	229	ESR20B51-***	\$1,231	\$1,389	\$1,469	\$1,348
	5"	.156"	1	2'-0"	3"	4' x 6'	160	262	ESR20C51-***	\$1,371	\$1,536	\$1,609	\$1,490
	5"	.188"	1	2'-0"	3"	4' x 6'	182	287	ESR20D51-***	\$1,557	\$1,721	\$1,796	\$1,670
	6"	.156"	1	2'-0"	3.5"	4' x 6'	208	301	ESR20C61-***	\$1,653	\$1,851	\$1,891	\$1,795
	6"	.188"	1	2'-0"	3.5"	4' x 6'	229	328	ESR20D61-***	\$2,076	\$2,275	\$2,315	\$2,207
25'	4"	.125"	1	2'-6"	2"	5' x 8'	83	106	ESR25B41-***	\$974	\$1,117	\$1,196	\$1,084
	5"	.125"	1	2'-6"	3"	5' x 8'	98	136	ESR25B51-***	\$1,338	\$1,551	\$1,631	\$1,505
	5"	.156"	1	2'-6"	3"	5' x 8'	111	178	ESR25C51-***	\$1,583	\$1,797	\$1,876	\$1,742
	5"	.188"	1	2'-6"	3"	5' x 8'	124	209	ESR25D51-***	\$1,914	\$2,123	\$2,208	\$2,059
	5.5"	.188"	1	2'-6"	3.5"	5' x 8'	146	231	ESR25DH1-***	\$2,028	\$2,275	\$2,377	\$2,207
	6"	.156"	1	2'-6"	3.5"	5' x 8'	149	230	ESR25C61-***	\$1,979	\$2,231	\$2,329	\$2,164
	6"	.188"	1	2'-6"	3.5"	5' x 8'	168	253	ESR25D61-***	\$2,443	\$2,677	\$2,724	\$2,596
30'	5"	.125"	1	3'-0"	3"	6' x 10'	78	96	ESR30B51-***	\$1,501	\$1,753	\$1,839	\$1,702
	5"	.125"	2	3'-0"	3"	6' x 10'	78	96	ESR30B52-***	\$1,583	\$1,835	\$1,920	\$1,779
	5"	.156"	1	3'-0"	3"	6' x 10'	86	112	ESR30C51-***	\$1,782	\$2,035	\$2,121	\$1,974
	5"	.156"	2	3'-0"	3"	6' x 10'	86	112	ESR30C52-***	\$1,866	\$2,119	\$2,204	\$2,054
	5"	.188"	1	3'-0"	3"	6' x 10'	94	131	ESR30D51-***	\$1,973	\$2,225	\$2,310	\$2,158
	5"	.188"	2	3'-0"	3"	6' x 10'	94	131	ESR30D52-***	\$2,052	\$2,267	\$2,390	\$2,198
	6"	.156"	1	3'-0"	3.5"	6' x 10'	108	174	ESR30C61-***	\$2,170	\$2,461	\$2,564	\$2,388
	6"	.156"	2	3'-0"	3.5"	6' x 10'	108	174	ESR30C62-***	\$2,283	\$2,574	\$2,677	\$2,497
	6"	.188"	1	3'-0"	3.5"	6' x 10'	122	197	ESR30D61-***	\$2,273	\$2,564	\$2,666	\$2,487
35'	5"	.125"	1	3'-6"	3"	6' x 10'	66	78	ESR35B51-***	\$1,553	\$1,703	\$1,851	\$1,652
	5"	.156"	1	3'-6"	3"	6' x 10'	73	87	ESR35C51-***	\$1,973	\$2,264	\$2,377	\$2,195
	5"	.156"	2	3'-6"	3"	6' x 10'	73	87	ESR35C52-***	\$2,050	\$2,341	\$2,454	\$2,271
	5"	.188"	1	3'-6"	3"	6' x 10'	79	95	ESR35D51-***	\$2,004	\$2,296	\$2,409	\$2,226
	5"	.188"	2	3'-6"	3"	6' x 10'	79	95	ESR35D52-***	\$2,068	\$2,359	\$2,474	\$2,288
	6"	.156"	1	3'-6"	3.5"	6' x 10'	87	116	ESR35C61-***	\$2,311	\$2,652	\$2,793	\$2,572
	6"	.156"	2	3'-6"	3.5"	6' x 10'	87	116	ESR35C62-***	\$2,397	\$2,738	\$2,880	\$2,656
	6"	.188"	1	3'-6"	3.5"	6' x 10'	97	145	ESR35D61-***	\$2,811	\$3,152	\$3,271	\$3,056
	6"	.188"	2	3'-6"	3.5"	6' x 10'	97	145	ESR35D62-***	\$2,995	\$3,336	\$3,479	\$3,235
	7"	.156"	1	3'-6"	3.5"	6' x 10'	110	165	ESR35C71-***	\$2,615	\$3,026	\$3,174	\$2,935
	7"	.156"	2	3'-6"	3.5"	6' x 10'	110	165	ESR35C72-***	\$2,768	\$3,185	\$3,328	\$3,088
	7"	.188"	1	3'-6"	3.5"	6' x 10'	127	187	ESR35D71-***	\$2,969	\$3,380	\$3,528	\$3,279
	7"	.188"	2	3'-6"	3.5"	6' x 10'	127	187	ESR35D72-***	\$3,083	\$3,499	\$3,643	\$3,395
40'	7"	.156"	1	4'-0"	3.5"	8' x 12'	87	122	ESR40C71-***	\$2,768	\$3,198	\$3,343	\$3,102
	7"	.156"	2	4'-0"	3.5"	8' x 12'	87	122	ESR40C72-***	\$3,332	\$3,798	\$3,946	\$3,685
	8"	.156"	1	4'-0"	4"	8' x 12'	107	157	ESR40C81-***	\$3,113	\$3,632	\$3,805	\$3,523
	8"	.156"	2	4'-0"	3.5"	8' x 12'	107	157	ESR40C82-***	\$3,675	\$4,230	\$4,407	\$4,103
	8"	.188"	1	4'-0"	4"	8' x 12'	123	177	ESR40D81-***	\$3,343	\$3,863	\$4,023	\$3,747
45'	8"	.188"	2	4'-6"	3.5"	8' x 12'	102	144	ESR45D82-***	\$4,447	\$5,024	\$5,246	\$4,874
	50'	8"	.188"	3	5'-0"	3.5"	10' x 15'	83	117	ESR50D83-***	\$4,795	\$5,438	\$5,699
55'	10"	.188"	3	5'-0"	4"	10' x 15'	118	164	ESR50D13-***	\$5,997	\$6,777	\$7,090	\$6,573
	55'	10"	.188"	3	5'-6"	4"	10' x 15'	102	139	ESR55D13-***	\$6,525	\$7,304	\$7,623
60'	10"	.188"	3	6'-0"	4"	12' x 18'	86	118	ESR60D13-***	\$6,823	\$7,750	\$8,098	\$7,517
	10"	.250"	3	6'-0"	4"	12' x 18'	104	143	ESR60F13-***	\$8,618	\$9,546	\$9,899	\$9,259
	12"	.250"	3	6'-0"	4"	12' x 18'	137	187	ESR60F23-***	\$10,961	\$12,081	\$12,479	\$11,718
65'	10"	.312"	3	6'-6"	4"	12' x 18'	106	142	ESR65G13-***	\$10,369	\$11,487	\$11,881	\$11,143
	12"	.250"	3	6'-6"	4"	12' x 18'	122	165	ESR65F23-***	\$11,753	\$12,933	\$13,361	\$12,545
70'	10"	.312"	3	7'-0"	4"	12' x 18'	94	123	ESR70G13-***	\$10,661	\$11,781	\$12,180	\$11,427
	12"	.250"	3	7'-0"	4"	12' x 18'	109	145	ESR70F23-***	\$12,260	\$13,506	\$13,961	\$13,101
75'	12"	.375"	3	7'-6"	4"	12' x 18'	126	161	ESR75H23-***	\$15,223	\$16,728	\$17,368	\$16,226
80'	12"	.375"	3	8'-0"	4"	15' x 25'	107	144	ESR80H23-***	\$15,671	\$17,175	\$17,815	\$16,660
	12"	.375"	4	8'-0"	4"	15' x 25'	107	144	ESR80H24-***	\$15,377	\$16,862	\$17,543	\$16,388

*** - Finish Options
 SAT = Satin
 ACL = Anodized - Clear
 ADB = Anodized - Dark Bronze
 ABL = Anodized - Black
 BZT = Powder Coat - BronzeTone
 BLK = Powder Coat - Black
 WHT = Powder Coat - White
 CLR = Powder Coat - Clear

Quantity Discounts 5+ = 5% 8+ = 10% 15+12%
 *Flagpoles From All Flagpole Series May Be Combined To Achieve Quantity Discounts.



Xtreme Series - XESR

Xtreme External Single Revolving - Rope Halyard

The **Xtreme Series XESR** from Concord American Flagpole provides the unmatched strength of our Xtreme Series External Single Revolving design in heights of **25' to 70'**.

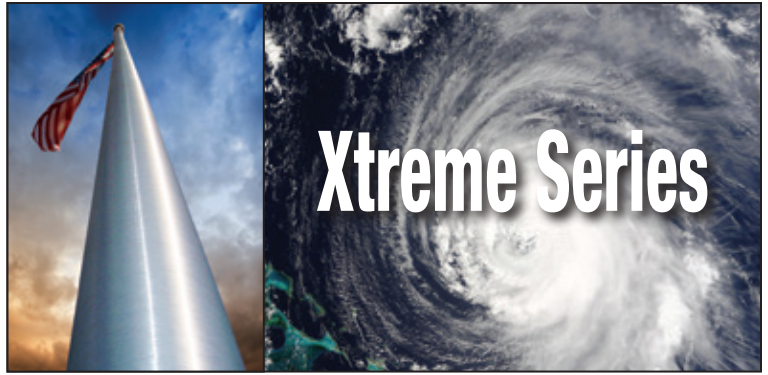

XESR – Xtreme External Single Revolving

The **Xtreme Series** from Concord American Flagpole provides flagpole owners with the **Increased Wind Speed Ratings** necessary in coastal, high wind, oversized and multiple flag applications. Years of Engineering, R & D and Manufacturing experience have merged to create the strongest, most efficient increased wind speed flagpoles, combining superior strength with the highest quality **Heavy-Duty Component Parts** in the industry... External Single Revolving Trucks with Dual SEALED Bearing Assemblies and Stainless Steel Spindle, 3/8" Polyester Halyard, Stainless Steel Swivel Flagnaps and Cast Aluminum Collars.

STANDARD FLAGPOLE ACCESSORIES - 6" TO 12" BUTT DIAMETERS

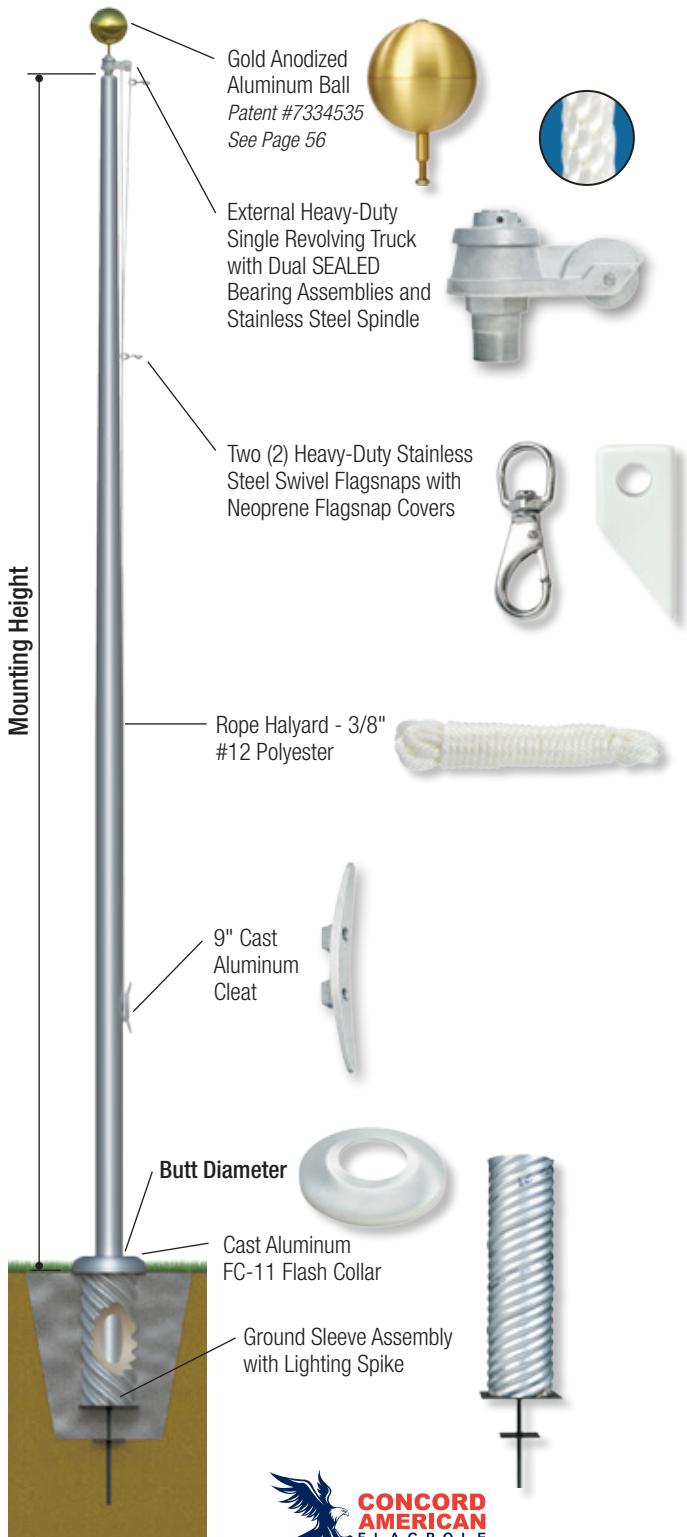

Standard Specifications

- Patented, Heavy-Duty Gold Anodized Aluminum Ball
- Heavy-Duty Cast Aluminum Revolving Truck with Dual SEALED Bearing Assemblies, Aluminum Pulley and Stainless Steel Spindle
- Complete External Halyard Assembly
 - Rope Halyard - Heavy-Duty 3/8" #12 Polyester
 - Two (2) Heavy-Duty Stainless Steel Swivel Flagnaps
 - Two (2) Neoprene Flagnap Covers
- 9" Cast Aluminum Cleat
- Heavy-Duty Cast Aluminum FC-11 Flash Collar
- Galvanized 16-Gauge Corrugated Steel Ground Sleeve with Steel Grounding Spike

Standard Upgrades – 10" and 12" Butt Diameters

- Heavy-Duty 5/8" Ball Stem
- Two (2) Heavy-Duty 4-1/4" Stainless Steel Flagnaps with Covers



Xtreme Series - XESR Xtreme External Single Revolving - Rope Halyard

MTG. HGT.	BUTT DIA.	WALL THICKNESS	POLE SECTIONS	SET DEPTH	TOP DIA.	STD. FLAG SIZE	MAX WIND SPEED WITH NYLON FLAG	MAX WIND SPEED NO FLAG	CATALOG NUMBER ***SPECIFY FINISH	SATIN	CLEAR ANODIZED	DARK BRONZE OR BLACK ANODIZED	BRONZE TONE, BLACK, WHITE OR CLEAR POWDERCOAT
25'	6"	.250"	1	2'-6"	3.5"	5' x 8'	197	287	XESR25F61-***	\$2,606	\$2,846	\$2,943	\$2,761
30'	6"	.250"	1	3'-0"	3.5"	6' x 10'	150	229	XESR30F61-***	\$3,086	\$3,369	\$3,422	\$3,267
			2	3'-0"	3.5"	6' x 10'	150	229	XESR30F62-***	\$3,395	\$3,705	\$3,765	\$3,595
	7"	.188"	1	3'-0"	3.5"	6' x 10'	157	235	XESR30D71-***	\$2,675	\$3,044	\$3,151	\$2,952
			2	3'-0"	3.5"	6' x 10'	157	235	XESR30D72-***	\$2,945	\$3,347	\$3,465	\$3,247
35'	7"	.250"	1	3'-6"	3.5"	6' x 10'	153	219	XESR35F71-***	\$3,198	\$3,838	\$3,998	\$3,723
	8"	.250"	2	3'-6"	4"	6' x 10'	181	249	XESR35F82-***	\$3,912	\$4,185	\$4,360	\$4,058
40'	8"	.250"	1	4'-0"	4"	8' x 12'	146	207	XESR40F81-***	\$4,611	\$5,149	\$5,320	\$4,995
			2	4'-0"	4"	8' x 12'	146	207	XESR40F82-***	\$4,842	\$5,407	\$5,586	\$5,244
	8"	.312"	2	4'-0"	4"	8' x 12'	165	231	XESR40G82-***	\$5,330	\$5,863	\$6,130	\$5,687
45'	10"	.250"	2	4'-6"	4"	8' x 12'	168	226	XESR45F12-***	\$6,226	\$6,551	\$6,785	\$6,354
50'	10"	.250"	3	5'-0"	4"	10' x 15'	140	191	XESR50F13-***	\$6,711	\$7,036	\$7,462	\$6,825
			3	5'-0"	4"	10' x 15'	158	213	XESR50G13-***	\$8,417	\$9,253	\$9,470	\$8,976
	12"	.250"	3	5'-0"	4"	10' x 15'	179	242	XESR50F23-***	\$9,168	\$10,013	\$10,226	\$9,712
60'	12"	.312"	3	6'-0"	4"	12' x 18'	155	209	XESR60G23-***	\$10,661	\$11,513	\$11,727	\$11,168
			3	6'-0"	4"	12' x 18'	171	228	XESR60H23-***	\$13,060	\$13,921	\$14,146	\$13,504
70'	12"	.375"	3	7'-0"	4"	12' x 18'	139	181	XESR70H23-***	\$14,605	\$15,459	\$15,810	\$14,995

*** - Finish Options

- SAT = Satin
- ACL = Anodized - Clear
- ADB = Anodized - Dark Bronze
- ABL = Anodized - Black
- BZT = Powder Coat - BronzeTone
- BLK = Powder Coat - Black
- WHT = Powder Coat - White
- CLR = Powder Coat - Clear

Quantity Discounts

5+ = 5% 8+ = 10% 15+ = 12%
 *Flagpoles From All Flagpole Series May Be Combined To Achieve Quantity Discounts.

XTREME SERIES - XESR OPTIONS

Double Revolving System with Heavy-Duty Dual SEALED Bearing Assemblies (Double Truck, Extra Cleat and Complete Double Halyard Assembly) – Specify XEDR (Xtreme External Double Revolving).
 See Page 61 Add **\$115**

Cast Aluminum, SEALED Bearings, Gold Powder Coated Ball Truck. Replaces Standard Truck and Ball Combination - See Page 63.

8" Diameter Ball/Truck Add **\$135**
 10" Diameter Ball/Truck Add **\$180**
 12" Diameter Ball/Truck Add **\$325**

Cleat Cover Box (Specify Cylinder Lock or Padlock). See Page 75 Add **\$130**

Cleat Cover Box with 5' Halyard Cover (Specify Cylinder Lock or Padlock) - See Page 75.
 6" Flagpole Butt Diameters Add **\$250**
 7"-12" Flagpole Butt Diameters Add **\$300**

Flagpole Lighting Options are available for all Xtreme Series XESR Flagpoles – See Pages 82-89.

Shoe Base Designs for Surface Mount Installations are available with all Xtreme Series – XESR Flagpoles. See Page 14.

- 6"-8" Butt Diameters Add **\$260**
- 10" Butt Diameters Add **\$520**
- 12" Butt Diameters Add **\$1,035**

Our **INDUSTRY-FIRST Lifetime Flagpole Shaft Warranty** assures that a Concord American Flagpole Xtreme Series Flagpole will withstand the worst Mother Nature can throw at it... **Guaranteed!**



Monarch Series - ICC

Internal Cam Cleat - Rope Halyard

The **Monarch Series** from Concord American Flagpole offers commercial-grade flagpoles with the security of an Internal Rope Halyard and Cam Cleat system. Ranging in heights from **20' to 40'**, the concealed halyard and lockable flush mount hinged door delivers project owners the peace of mind provided with 24-7 security.

STANDARD FLAGPOLE ACCESSORIES - 5" TO 8" BUTT DIAMETERS

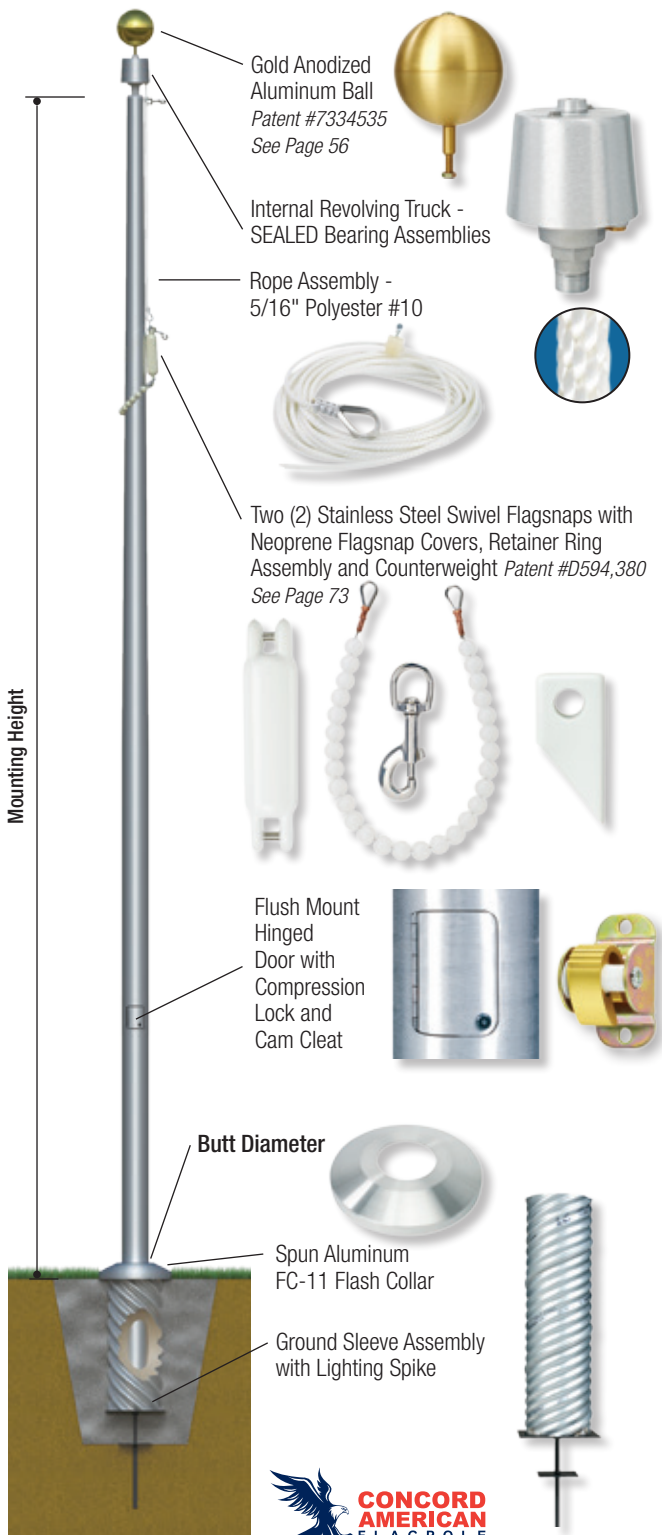

Standard Specifications

- Patented, Heavy-Duty Gold Anodized Aluminum Ball
- Cast Aluminum Revolving Truck with SEALED Stainless Steel Bearing Assemblies, Aluminum Spindle, Cast Brass Exit Bushing and Removable Hood
- Complete External Halyard Assembly
 - Rope Halyard – 5/16" #10 Wire Center Polyester
 - Two (2) Stainless Steel Swivel Flagsnaps
 - Two (2) Neoprene Flagsnap Covers
- Cam Cleat
- Flush Mount Access Door with Lock and Keys
- Spun Aluminum FC-11 Flash Collar
- Galvanized 16-Gauge Corrugated Steel Ground Sleeve with Steel Grounding Spike

Flush Mount Hinged Door Design

Monarch Flagpoles unite the simplicity of efficient engineering with the aesthetics of a precision cut, rectangular flush mount door design, providing an internal halyard Cam Cleat system that is ideal for low to moderate wind speed areas.

For additional Cam Cleat option flagpoles, see Sentry ISC Raised Reinforced Door Frame (Page 26) and Sentry II IRC Reinforced Welded Door Frame (Page 28).



Monarch Series - ICC Internal Cam Cleat - Rope Halyard

MTG. HGT.	BUTT DIA.	WALL THICKNESS	POLE SECTIONS	SET DEPTH	TOP DIA.	STD. FLAG SIZE	MAX WIND SPEED WITH NYLON FLAG	MAX WIND SPEED NO FLAG	CATALOG NUMBER ***SPECIFY FINISH	SATIN	BRONZE TONE, BLACK, WHITE OR CLEAR POWDERCOAT		
											CLEAR ANODIZED	DARK BRONZE OR BLACK ANODIZED	BRONZE TONE, BLACK, WHITE OR CLEAR POWDERCOAT
20'	5"	.125"	1	2'0"	3"	4' x 6'	117	204	ICC20B51-***	\$1,676	\$1,884	\$1,943	\$1,810
	5"	.188"	1	2'0"	3"	4' x 6'	151	272	ICC20D51-***	\$1,906	\$2,118	\$2,177	\$2,045
25'	5"	.125"	1	2'6"	3"	5' x 8'	84	110	ICC25B51-***	\$1,791	\$2,060	\$2,118	\$1,956
	5"	.156"	1	2'6"	3"	5' x 8'	93	129	ICC25C51-***	\$2,007	\$2,236	\$2,337	\$2,162
	6"	.156"	1	2'6"	3.5"	5' x 8'	126	216	ICC25C61-***	\$2,338	\$2,616	\$2,748	\$2,498
	6"	.188"	1	2'6"	3.5"	5' x 8'	144	240	ICC25D61-***	\$2,467	\$2,777	\$2,909	\$2,644
30'	5"	.156"	1	3'0"	3"	6' x 10'	72	90	ICC30C51-***	\$2,165	\$2,484	\$2,586	\$2,367
	5"	.156"	2	3'0"	3"	6' x 10'	72	90	ICC30C52-***	\$2,384	\$2,729	\$2,844	\$2,804
	6"	.156"	1	3'0"	3.5"	6' x 10'	91	138	ICC30C61-***	\$2,468	\$2,820	\$2,953	\$2,675
	6"	.156"	2	3'0"	3.5"	6' x 10'	91	138	ICC30C62-***	\$2,716	\$3,102	\$3,248	\$2,945
	6"	.188"	1	3'0"	3.5"	6' x 10'	102	170	ICC30D61-***	\$2,612	\$2,968	\$3,085	\$2,820
	6"	.188"	2	3'0"	3.5"	6' x 10'	102	170	ICC30D62-***	\$2,878	\$3,264	\$3,395	\$3,077
35'	6"	.156"	1	3'6"	3.5"	6' x 10'	74	93	ICC35C61-***	\$2,627	\$3,204	\$3,331	\$2,850
	6"	.156"	2	3'6"	3.5"	6' x 10'	74	93	ICC35C62-***	\$2,889	\$3,524	\$3,663	\$3,136
	7"	.156"	1	3'6"	3.5"	6' x 10'	95	142	ICC35C71-***	\$2,900	\$3,319	\$3,496	\$3,130
	7"	.156"	2	3'6"	3.5"	6' x 10'	95	142	ICC35C72-***	\$3,190	\$3,653	\$3,846	\$3,443
	7"	.188"	1	3'6"	3.5"	6' x 10'	107	167	ICC35D71-***	\$3,275	\$3,701	\$3,876	\$3,512
	7"	.188"	2	3'6"	3.5"	6' x 10'	107	167	ICC35D72-***	\$3,603	\$4,073	\$4,264	\$3,864
40'	7"	.156"	1	4'0"	3.5"	8' x 12'	75	99	ICC40C71-***	\$3,401	\$3,979	\$4,130	\$3,806
	7"	.156"	2	4'0"	3.5"	8' x 12'	75	99	ICC40C72-***	\$3,742	\$4,377	\$4,544	\$4,188
	8"	.156"	1	4'0"	4"	8' x 12'	94	140	ICC40C81-***	\$3,625	\$4,158	\$4,318	\$3,838
	8"	.156"	2	4'0"	4"	8' x 12'	94	140	ICC40C82-***	\$3,987	\$4,574	\$4,751	\$4,222
	8"	.188"	1	4'0"	4"	8' x 12'	107	161	ICC40D81-***	\$3,806	\$4,266	\$4,497	\$4,037
	8"	.188"	2	4'0"	4"	8' x 12'	107	161	ICC40D82-***	\$4,188	\$4,693	\$4,946	\$4,439

*** - Finish Options

- SAT = Satin
- ACL = Anodized - Clear
- ADB = Anodized - Dark Bronze
- ABL = Anodized - Black
- BZT = Powder Coat - BronzeTone
- BLK = Powder Coat - Black
- WHT = Powder Coat - White
- CLR = Powder Coat - Clear

Quantity Discounts

5+ = 5% 8+ = 10% 15+ = 12%
 *Flagpoles From All Flagpole Series May Be Combined To Achieve Quantity Discounts.

MONARCH SERIES - ICC OPTIONS

Cast Aluminum, SEALED Bearings, Gold Powder Coated Ball Truck.
 Replaces Standard Truck and Ball Combination - See Page 66.



8" Diameter Ball/Truck Add **\$135**

Cast Aluminum FC-11 In Lieu of Spun Collar - See Page 79.



5"-7" Butt Diameters Add **\$55**
 8" Butt Diameters Add **\$165**

Flagpole Lighting Options are available for all Monarch Series ICC Flagpoles - See Pages 82-89.

Shoe Base Designs for Surface Mount Installations are available with all Monarch Series - ICC Flagpoles. See Page 14.

5" Butt Diameters Add **\$210**
 6"-8" Butt Diameters Add **\$260**

Sentry Series - ISC

Internal Cam Cleat with Reinforced Raised Door Frame - Rope Halyard

The **Sentry Series** from Concord American Flagpole offers Cam Cleat system flagpoles in heights from **20' to 40'**. The raised reinforced door frame design provides the security of an Internal Rope Halyard and Cam Cleat system with the reinforced strength necessary for moderate wind speed areas.

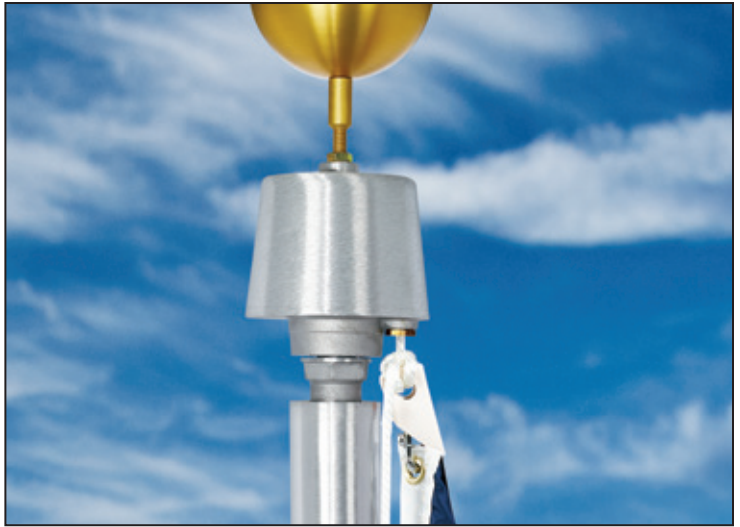

STANDARD FLAGPOLE ACCESSORIES - 5" TO 7" BUTT DIAMETERS



Standard Specifications

- Patented, Heavy-Duty Gold Anodized Aluminum Ball
- Cast Aluminum Revolving Truck with SEALED Stainless Steel Bearing Assemblies, Aluminum Spindle, Cast Brass Exit Bushing and Removable Hood
- Complete External Halyard Assembly
 - Rope Halyard – 5/16" #10 Wire Center Polyester
 - Two (2) Stainless Steel Flagnaps
 - Two (2) Neoprene Flagnap Covers
- Cam Cleat
- Reinforced Raised Door Frame
- Flush Mount Access Door with Lock and Keys
- Spun Aluminum FC-11 Flash Collar
- Galvanized 16-Gauge Corrugated Steel Ground Sleeve with Steel Grounding Spike

Reinforced Raised Door Frame

Sentry Flagpoles are designed with a patented raised reinforced door frame consisting of a matched set of inner and outer castings. The frame castings are attached to the flagpole shaft using a series of eight (8) tamper-proof 5/16-18NC stainless steel bolts. The aluminum door is secured with two (2) tamper-proof 1/4-20NC screws. **For additional Cam Cleat option flagpoles, see Monarch ICC Flush Mount Hinged Door Design (Page 24) and Sentry II IRC Reinforced Welded Door Frame (Page 28).**



Patent #7717055



Sentry Series - ISC Internal Cam Cleat with Reinforced Raised Door Frame - Rope Halyard

MTG. HGT.	BUTT DIA.	WALL THICKNESS	POLE SECTIONS	SET DEPTH	TOP DIA.	STD. FLAG SIZE	MAX WIND SPEED WITH NYLON FLAG	MAX WIND SPEED NO FLAG	CATALOG NUMBER ***SPECIFY FINISH	BRONZE TONE, BLACK, WHITE OR CLEAR POWDERCOAT			
										SATIN	CLEAR ANODIZED	DARK BRONZE OR BLACK ANODIZED	BRONZE TONE, BLACK, WHITE OR CLEAR POWDERCOAT
20'	5"	.125"	1	2'0"	3"	4' x 6'	136	229	ISC20B51-***	\$1,589	\$1,753	\$1,824	\$1,702
	5"	.156"	1	2'0"	3"	4' x 6'	160	262	ISC20C51-***	\$1,738	\$1,903	\$1,974	\$1,845
	5"	.188"	1	2'0"	3"	4' x 6'	182	287	ISC20D51-***	\$1,924	\$2,090	\$2,161	\$2,027
	6"	.156"	1	2'0"	3.5"	4' x 6'	208	301	ISC20C61-***	\$2,010	\$2,207	\$2,245	\$2,140
	6"	.188"	1	2'0"	3.5"	4' x 6'	229	328	ISC20D61-***	\$2,436	\$2,633	\$2,671	\$2,554
25'	5"	.125"	1	2'6"	3"	5' x 8'	98	136	ISC25B51-***	\$1,721	\$1,935	\$2,013	\$1,877
	5"	.156"	1	2'6"	3"	5' x 8'	111	178	ISC25C51-***	\$1,961	\$2,176	\$2,252	\$2,110
	5"	.188"	1	2'6"	3"	5' x 8'	124	209	ISC25D51-***	\$2,330	\$2,538	\$2,621	\$2,462
	6"	.156"	1	2'6"	3.5"	5' x 8'	149	230	ISC25C61-***	\$2,425	\$2,634	\$2,716	\$2,555
	6"	.188"	1	2'6"	3.5"	5' x 8'	168	253	ISC25D61-***	\$2,500	\$2,747	\$2,845	\$2,665
30'	5"	.156"	1	3'0"	3"	6' x 10'	86	112	ISC30C51-***	\$2,148	\$2,400	\$2,483	\$2,328
	5"	.156"	2	3'0"	3"	6' x 10'	86	112	ISC30C52-***	\$2,234	\$2,486	\$2,568	\$2,412
	5"	.188"	1	3'0"	3"	6' x 10'	94	131	ISC30D51-***	\$2,345	\$2,598	\$2,680	\$2,520
	5"	.188"	2	3'0"	3"	6' x 10'	94	131	ISC30D52-***	\$2,452	\$2,704	\$2,786	\$2,624
	6"	.156"	1	3'0"	3.5"	6' x 10'	108	174	ISC30C61-***	\$2,553	\$2,844	\$2,944	\$2,759
	6"	.156"	2	3'0"	3.5"	6' x 10'	108	174	ISC30C62-***	\$2,665	\$2,956	\$3,055	\$2,868
	6"	.188"	1	3'0"	3.5"	6' x 10'	122	197	ISC30D61-***	\$2,715	\$2,946	\$3,045	\$2,858
	6"	.188"	2	3'0"	3.5"	6' x 10'	122	197	ISC30D62-***	\$2,772	\$3,068	\$3,167	\$2,976
35'	5"	.156"	1	3'6"	3"	6' x 10'	73	87	ISC35C51-***	\$2,345	\$2,636	\$2,746	\$2,557
	5"	.156"	2	3'6"	3"	6' x 10'	73	87	ISC35C52-***	\$2,420	\$2,710	\$2,819	\$2,629
	5"	.188"	1	3'6"	3"	6' x 10'	79	95	ISC35D51-***	\$2,452	\$2,743	\$2,852	\$2,661
	5"	.188"	2	3'6"	3"	6' x 10'	79	95	ISC35D52-***	\$2,665	\$2,956	\$3,066	\$2,868
	6"	.156"	1	3'6"	3.5"	6' x 10'	87	116	ISC35C61-***	\$2,681	\$3,021	\$3,159	\$2,930
	6"	.156"	2	3'6"	3.5"	6' x 10'	87	116	ISC35C62-***	\$2,777	\$3,117	\$3,255	\$3,023
	6"	.188"	1	3'6"	3.5"	6' x 10'	97	145	ISC35D61-***	\$3,193	\$3,532	\$3,670	\$3,427
	6"	.188"	2	3'6"	3.5"	6' x 10'	97	145	ISC35D62-***	\$3,417	\$3,757	\$3,895	\$3,644
	7"	.156"	1	3'6"	3.5"	6' x 10'	110	165	ISC35C71-***	\$3,022	\$3,434	\$3,577	\$3,331
	7"	.156"	2	3'6"	3.5"	6' x 10'	110	165	ISC35C72-***	\$3,176	\$3,594	\$3,731	\$3,486
	7"	.188"	1	3'6"	3.5"	6' x 10'	127	187	ISC35D71-***	\$3,369	\$3,780	\$3,923	\$3,667
7"	.188"	2	3'6"	3.5"	6' x 10'	127	187	ISC35D72-***	\$3,491	\$3,903	\$4,046	\$3,786	
40'	7"	.156"	1	4'0"	3.5"	8' x 12'	87	122	ISC40C71-***	\$3,531	\$3,978	\$4,130	\$3,858
	7"	.156"	2	4'0"	3.5"	8' x 12'	87	122	ISC40C72-***	\$3,640	\$4,108	\$4,238	\$3,985

*** - Finish Options

- SAT = Satin
- ACL = Anodized - Clear
- ADB = Anodized - Dark Bronze
- ABL = Anodized - Black
- BZT = Powder Coat - BronzeTone
- BLK = Powder Coat - Black
- WHT = Powder Coat - White
- CLR = Powder Coat - Clear

Quantity Discounts

5+ = 5% 8+ = 10% 15+ = 12%
 *Flagpoles From All Flagpole Series May Be Combined To Achieve Quantity Discounts.

SENTRY SERIES - ISC OPTIONS

Cast Aluminum, SEALED Bearings, Gold Powder Coated Ball Truck.
 Replaces Standard Truck and Ball Combination - See Page 66.



8" Diameter Ball/Truck Add \$135

Cast Aluminum FC-11 In Lieu of Spun Collar - See Page 79.
 5"-7" Butt Diameters Add \$55



Flagpole Lighting Options are available for all Sentry Series ISC Flagpoles – See Pages 82-89.

Shoe Base Designs for Surface Mount Installations are available with all Continental Series – ESR Flagpoles. See Page 14.

5" Butt Diameters Add \$210
 6"-7" Butt Diameters Add \$260

Sentry II Series - IRC

Internal Reinforced with Cam Cleat - Rope Halyard

The **Sentry II** Series from Concord American Flagpole is the perfect choice when your project calls for a commercial grade flagpole utilizing an Internal Rope Halyard and Cam Cleat system. Offered in heights of **20' to 40'**, the reinforced welded door frame delivers exceptional strength, combining security with the superior aesthetics achieved from the lockable flush mount door.



STANDARD FLAGPOLE ACCESSORIES - 6" TO 8" BUTT DIAMETERS



Standard Specifications

- Patented, Heavy-Duty Gold Anodized Aluminum Ball
- Cast Aluminum Revolving Truck with SEALED Stainless Steel Bearing Assemblies, Aluminum Spindle, Cast Brass Exit Bushing and Removable Hood
- Complete External Halyard Assembly
 - Rope Halyard – 5/16" #10 Wire Center Polyester
 - Two (2) Stainless Steel Swivel Flagsnaps
 - Two (2) Neoprene Flagsnap Covers
- Cam Cleat
- Reinforced Welded Door Frame
- Flush Mount Access Door with Lock and Keys
- Spun Aluminum FC-11 Flash Collar
- Galvanized 16-Gauge Corrugated Steel Ground Sleeve with Steel Grounding Spike

Reinforced Welded Door Frame

Sentry II Flagpoles are engineered with an inset reinforced aluminum door frame welded into the precision cut door opening, providing additional strength and higher max wind speeds from each butt diameter/ wall thickness combination. The efficiency of this design produces maximum strength-to-size ratios while providing a smooth, flush fitting door, making our Sentry II IRC flagpoles the ideal choice in many applications. *For additional Cam Cleat option flagpoles, see Monarch ICC Flush Mount Hinged Door Design (Page 24) and Sentry ISC Raised Reinforced Door Frame (Page 26).*



Sentry II Series - IRC Internal Reinforced with Cam Cleat - Rope Halyard

MTG. HGT.	BUTT DIA.	WALL THICKNESS	POLE SECTIONS	SET DEPTH	TOP DIA.	STD. FLAG SIZE	MAX WIND SPEED WITH NYLON FLAG	MAX WIND SPEED NO FLAG	CATALOG NUMBER ***SPECIFY FINISH	SATIN	CLEAR ANODIZED	DARK BRONZE OR BLACK ANODIZED	BRONZETONE, BLACK, WHITE OR CLEAR POWDERCOAT
20'	6"	.156"	1	2'0"	3.5"	4' x 6'	208	301	IRC20C61-***	\$2,196	\$2,393	\$2,435	\$2,322
	6"	.188"	1	2'0"	3.5"	4' x 6'	229	328	IRC20D61-***	\$2,663	\$2,860	\$2,901	\$2,775
25'	6"	.156"	1	2'6"	3.5"	5' x 8'	149	230	IRC25C61-***	\$2,548	\$2,795	\$2,897	\$2,711
	6"	.188"	1	2'6"	3.5"	5' x 8'	168	253	IRC25D61-***	\$2,801	\$3,047	\$3,150	\$2,955
30'	6"	.156"	1	3'0"	3.5"	6' x 10'	108	174	IRC30C61-***	\$2,745	\$3,022	\$3,138	\$2,931
	6"	.156"	2	3'0"	3.5"	6' x 10'	108	174	IRC30C62-***	\$2,882	\$3,173	\$3,276	\$3,078
	6"	.188"	1	3'0"	3.5"	6' x 10'	122	197	IRC30D61-***	\$2,964	\$3,256	\$3,359	\$3,158
	6"	.188"	2	3'0"	3.5"	6' x 10'	122	197	IRC30D62-***	\$3,075	\$3,366	\$3,468	\$3,264
	7"	.188"	1	3'0"	3.5"	6' x 10'	157	235	IRC30D71-***	\$2,992	\$3,333	\$3,474	\$3,232
35'	6"	.156"	1	3'6"	3.5"	6' x 10'	87	116	IRC35C61-***	\$3,097	\$3,437	\$3,579	\$3,334
	6"	.156"	2	3'6"	3.5"	6' x 10'	87	116	IRC35C62-***	\$3,509	\$3,848	\$3,990	\$3,733
	6"	.188"	1	3'6"	3.5"	6' x 10'	97	145	IRC35D61-***	\$3,651	\$3,991	\$4,133	\$3,872
	6"	.188"	2	3'6"	3.5"	6' x 10'	97	145	IRC35D62-***	\$3,349	\$3,761	\$3,909	\$3,648
	7"	.156"	1	3'6"	3.5"	6' x 10'	110	165	IRC35C71-***	\$3,486	\$3,899	\$4,046	\$3,782
	7"	.156"	2	3'6"	3.5"	6' x 10'	110	165	IRC35C72-***	\$3,559	\$3,957	\$4,046	\$3,838
	7"	.188"	1	3'6"	3.5"	6' x 10'	127	187	IRC35D71-***	\$3,733	\$4,150	\$4,293	\$4,025
	7"	.188"	2	3'6"	3.5"	6' x 10'	127	187	IRC35D72-***	\$3,871	\$4,283	\$4,431	\$4,153
8"	.188"	1	3'6"	4"	6' x 10'	155	213	IRC35D81-***	\$3,957	\$4,435	\$4,606	\$4,301	
40'	7"	.156"	2	4'0"	3.5"	8' x 12'	87	122	IRC40C72-***	\$4,035	\$4,502	\$4,640	\$4,367
	7"	.188"	1	4'0"	3.5"	8' x 12'	103	147	IRC40D71-***	\$4,117	\$4,604	\$4,753	\$4,465
	8"	.156"	1	4'0"	4"	8' x 12'	107	157	IRC40C81-***	\$3,676	\$3,992	\$4,146	\$3,873
	8"	.156"	2	4'0"	3.5"	8' x 12'	107	157	IRC40C82-***	\$4,365	\$4,918	\$5,096	\$4,771
	8"	.188"	1	4'0"	4"	8' x 12'	123	177	IRC40D81-***	\$4,170	\$4,693	\$4,857	\$4,552
	8"	.188"	2	4'0"	3.5"	8' x 12'	122	177	IRC40D82-***	\$4,584	\$5,139	\$5,317	\$4,985
	8"	.250"	1	4'0"	4"	8' x 12'	146	205	IRC40F81-***	\$4,904	\$5,371	\$5,513	\$5,209

*** - Finish Options

- SAT = Satin
- ACL = Anodized - Clear
- ADB = Anodized - Dark Bronze
- ABL = Anodized - Black
- BZT = Powder Coat - BronzeTone
- BLK = Powder Coat - Black
- WHT = Powder Coat - White
- CLR = Powder Coat - Clear

Quantity Discounts

5+ = 5% 8+ = 10% 15+ = 12%
 *Flagpoles From All Flagpole Series May Be Combined To Achieve Quantity Discounts.

SENTRY II SERIES - IRC OPTIONS

Cast Aluminum, SEALED Bearings, Gold Powder Coated Ball Truck.
 Replaces Standard Truck and Ball Combination - See Page 66.



8" Diameter Ball/Truck Add \$135

Cast Aluminum FC-11 In Lieu of Spun Collar - See Page 79.



6"-7" Butt Diameters Add \$55
 8" Butt Diameters Add \$165

Flagpole Lighting Options are available for all Sentry II Series IRC Flagpoles - See Pages 82-89.

Shoe Base Designs for Surface Mount Installations are available with all Sentry II Series - IRC Flagpoles.

See Page 14.
 6"-8" Butt Diameters Add \$260

Titan Series - IWW

Internal With Winch - Wire Halyard

The **Titan Series** from Concord American Flagpole offers commercial grade flagpoles with the security of an Internal Halyard Winch and Wire Cable system. Ranging in heights from **20' to 80'**, the concealed halyard and lockable flush mount hinged door delivers project owners the peace of mind provided with 24-7 security.



STANDARD FLAGPOLE ACCESSORIES - 6" TO 8" BUTT DIAMETERS

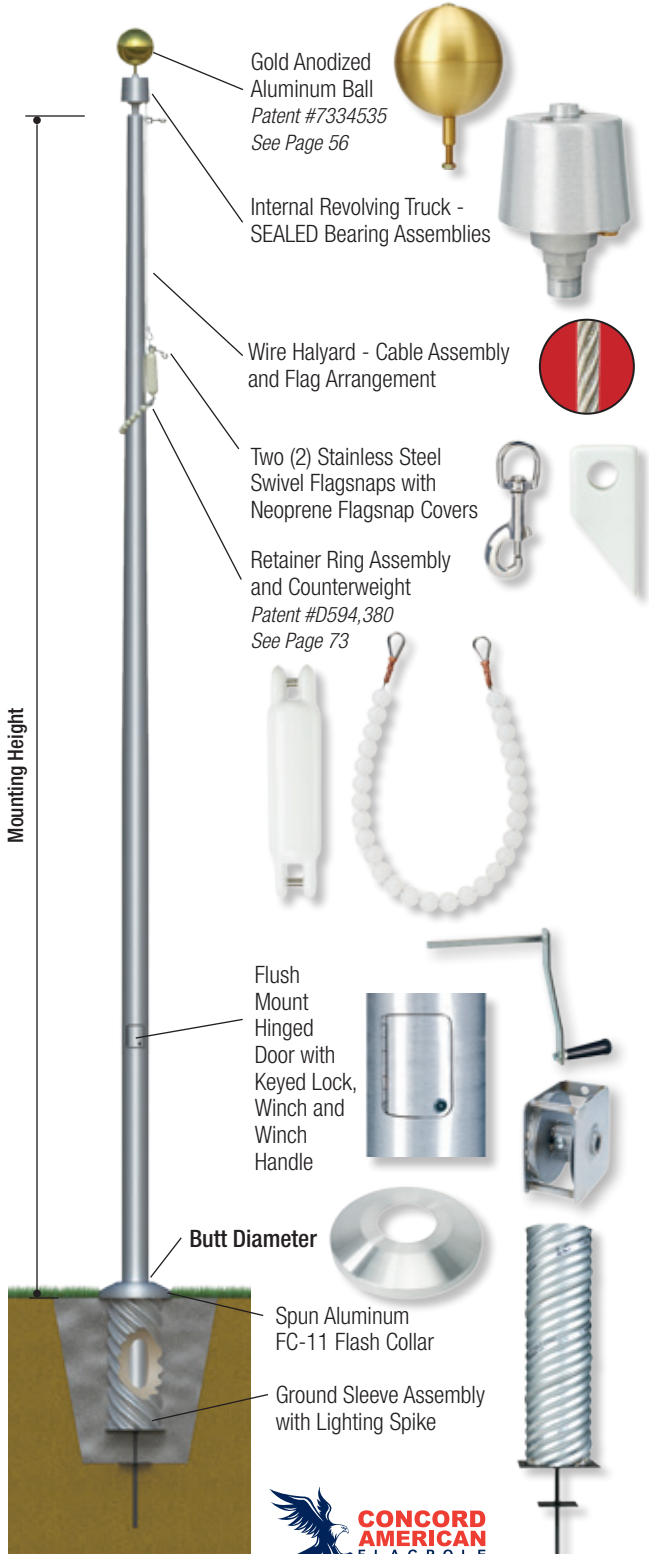

Standard Specifications

- Patented, Heavy-Duty Gold Anodized Aluminum Ball
- Cast Aluminum Revolving Truck with Dual SEALED Stainless Steel Bearing Assemblies, Aluminum Spindle, Cast Brass Exit Bushing and Removable Hood
- Complete Internal Halyard Assembly
 - Wire Halyard Cable Assembly
 - Flag Arrangement (8' x 12' and Larger Flags Include Heavy-Duty Shock Spring Assembly)
 - Two (2) Stainless Steel Swivel Flagnaps
 - Two (2) Neoprene Flagnap Covers
 - Patented, Plastic Coated Counterweight
 - Beaded Retainer Ring Assembly
- Stainless Steel Winch Assembly with Removable Hand Crank
- Flush Mount Access Door with Lock and Keys
- Spun Aluminum FC-11 Flash Collar
- Galvanized 16-Gauge Corrugated Steel Ground Sleeve with Steel Grounding Spike

Standard Upgrades – 10" and 12" Butt Diameters

- Heavy-Duty, Large Cast Aluminum Revolving Truck with Dual SEALED Stainless Steel Bearing Assemblies, Aluminum Spindle, Cast Brass Exit Bushing and Removable Hood
- Two (2) Heavy-Duty Stainless Steel Flagnaps
- Heavy-Duty Cast Aluminum FC-11 Flash Collar
- Heavy-Duty 5/8" Ball Stem

Flush Mount Hinged Door Design

Titan Flagpoles unite the simplicity of efficient engineering with the aesthetics of a precision cut, rectangular flush mount door design, providing an internal halyard Winch system that is ideal for low to moderate wind speed areas. **For additional Winch option flagpoles, see Sovereignty ISW Raised Reinforced Door Frame (Page 32) and Independence IRW Reinforced Welded Door Frame (Page 34).**



Titan Series - IWW Internal With Winch - Wire Halyard

MTG. HGT.	BUTT DIA.	WALL THICKNESS	POLE SECTIONS	SET DEPTH	TOP DIA.	STD. FLAG SIZE	MAX WIND SPEED WITH NYLON FLAG	MAX WIND SPEED NO FLAG	CATALOG NUMBER ***SPECIFY FINISH	BRONZE TONE, BLACK, WHITE OR CLEAR POWDERCOAT			
										SATIN	CLEAR ANODIZED	DARK BRONZE OR BLACK ANODIZED	BRONZE TONE, BLACK, WHITE OR CLEAR POWDERCOAT
20'	6"	.156"	1	2'0"	3.5"	4' x 6'	152	256	IWW20C61-***	\$2,306	\$2,882	\$3,055	\$2,710
	6"	.188"	1	2'0"	3.5"	4' x 6'	174	280	IWW20D61-***	\$2,597	\$3,053	\$3,176	\$2,918
25'	6"	.156"	1	2'6"	3.5"	5' x 8'	100	162	IWW25C61-***	\$2,871	\$3,240	\$3,362	\$3,113
	6"	.188"	1	2'6"	3.5"	5' x 8'	112	192	IWW25D61-***	\$2,993	\$3,312	\$3,430	\$3,180
30'	6"	.156"	1	3'0"	3.5"	6' x 10'	75	98	IWW30C61-***	\$3,194	\$3,561	\$3,693	\$3,414
	6"	.156"	2	3'0"	3.5"	6' x 10'	75	98	IWW30C62-***	\$3,514	\$3,919	\$4,062	\$3,780
	6"	.188"	1	3'0"	3.5"	6' x 10'	83	114	IWW30D61-***	\$3,482	\$3,854	\$3,986	\$3,707
	6"	.188"	2	3'0"	3.5"	6' x 10'	83	114	IWW30D62-***	\$3,830	\$4,240	\$4,383	\$4,079
	7"	.156"	1	3'0"	3.5"	6' x 10'	105	162	IWW30C71-***	\$3,231	\$3,672	\$3,805	\$3,462
	7"	.156"	2	3'0"	3.5"	6' x 10'	105	162	IWW30C72-***	\$3,554	\$4,041	\$4,186	\$3,808
	7"	.188"	1	3'0"	3.5"	6' x 10'	113	188	IWW30D71-***	\$3,747	\$4,116	\$4,249	\$3,978
	7"	.188"	2	3'0"	3.5"	6' x 10'	113	188	IWW30D72-***	\$4,121	\$4,528	\$4,674	\$4,375
35'	7"	.156"	1	3'6"	3.5"	6' x 10'	80	106	IWW35C71-***	\$3,769	\$4,206	\$4,382	\$4,001
	7"	.156"	2	3'6"	3.5"	6' x 10'	80	106	IWW35C72-***	\$4,149	\$4,626	\$4,821	\$4,401
	7"	.188"	1	3'6"	3.5"	6' x 10'	90	127	IWW35D71-***	\$4,086	\$4,528	\$4,704	\$4,338
	7"	.188"	2	3'6"	3.5"	6' x 10'	90	127	IWW35D72-***	\$4,494	\$4,980	\$5,175	\$4,771
	8"	.188"	1	3'6"	4"	6' x 10'	119	179	IWW35D81-***	\$4,202	\$4,664	\$4,842	\$4,485
	8"	.188"	2	3'6"	4"	6' x 10'	119	179	IWW35D82-***	\$4,622	\$5,129	\$5,326	\$4,614
40'	7"	.156"	1	4'0"	3.5"	8' x 12'	65	80	IWW40C71-***	\$4,150	\$4,727	\$4,900	\$4,497
	7"	.156"	2	4'0"	3.5"	8' x 12'	65	80	IWW40C72-***	\$4,564	\$5,200	\$5,390	\$4,946
	8"	.156"	1	4'0"	4"	8' x 12'	81	113	IWW40C81-***	\$4,497	\$5,074	\$5,361	\$4,842
	8"	.156"	2	4'0"	4"	8' x 12'	81	113	IWW40C82-***	\$4,626	\$5,580	\$5,897	\$5,326
	8"	.188"	1	4'0"	4"	8' x 12'	91	134	IWW40D81-***	\$4,727	\$5,361	\$5,534	\$5,074
	8"	.188"	2	4'0"	4"	8' x 12'	91	134	IWW40D82-***	\$5,200	\$5,897	\$6,087	\$5,580
	10"	.188"	2	4'0"	4"	8' x 12'	141	204	IWW40D12-***	\$5,074	\$5,707	\$5,880	\$5,418
	8"	.188"	2	4'6"	4"	8' x 12'	76	100	IWW45D82-***	\$5,381	\$5,950	\$6,112	\$5,760
50'	10"	.188"	3	5'0"	4"	10' x 15'	94	136	IWW50D13-***	\$6,533	\$7,605	\$8,002	\$7,122
	10"	.250"	3	5'0"	4"	10' x 15'	115	165	IWW50F13-***	\$7,598	\$8,646	\$9,051	\$8,071
60'	10"	.188"	3	6'0"	4"	12' x 18'	68	89	IWW60D13-***	\$7,367	\$8,442	\$8,911	\$8,061
	10"	.250"	3	6'0"	4"	12' x 18'	82	113	IWW60F13-***	\$9,124	\$10,479	\$10,947	\$9,922
	12"	.250"	3	6'0"	4"	12' x 18'	117	166	IWW60F23-***	\$11,338	\$13,014	\$13,483	\$12,179
70'	10"	.312"	3	7'0"	4"	12' x 18'	72	94	IWW70G13-***	\$10,936	\$12,486	\$12,956	\$11,696
	12"	.250"	3	7'0"	4"	12' x 18'	90	122	IWW70F23-***	\$12,475	\$14,451	\$15,066	\$13,336
80'	12"	.375"	4	8'0"	4"	15' x 25'	89	121	IWW80H24-***	\$15,712	\$18,056	\$18,833	\$16,795

*** - Finish Options

- SAT = Satin
- ACL = Anodized - Clear
- ADB = Anodized - Dark Bronze
- ABL = Anodized - Black
- BZT = Powder Coat - Bronze Tone
- BLK = Powder Coat - Black
- WHT = Powder Coat - White
- CLR = Powder Coat - Clear

Quantity Discounts

5+ = 5% 8+ = 10% 15+ = 12%
 *Flagpoles From All Flagpole Series May Be Combined To Achieve Quantity Discounts.

TITAN SERIES - IWW OPTIONS

Cast Aluminum, SEALED Bearings, Gold Powder Coated Ball Truck.
 Replaces Standard Truck and Ball Combination - See Page 66.

8" Diameter Ball/Truck Add \$135
 10" Diameter Ball/Truck Add \$180
 12" Diameter Ball/Truck Add \$325



Cast Aluminum FC-11 In Lieu of Spun Collar - See Page 79.
 6"-7" Butt Diameters Add \$55
 8"-12" Butt Diameters Add \$165



Flagpole Lighting Options are available for all Titan Series IWW Flagpoles - See Pages 82-89.

Shoe Base Designs for Surface Mount Installations are available with all Titan Series - IWW Flagpoles. See Page 14.

- 6"-8" Butt Diameters Add \$260
- 10" Butt Diameters Add \$520
- 12" Butt Diameters Add \$1,035



Sovereignty Series - ISW

Internal Winch with Reinforced Raised Door Frame

The **Sovereignty Series** from Concord American Flagpole offers flagpoles in butt diameters from **5" to 7"** and heights from **20' to 40'**. The raised reinforced door frame design combines the security of an Internal Halyard Winch and Wire Cable system with the reinforced strength necessary for moderate wind speed areas.

STANDARD FLAGPOLE ACCESSORIES - 5" TO 7" BUTT DIAMETERS

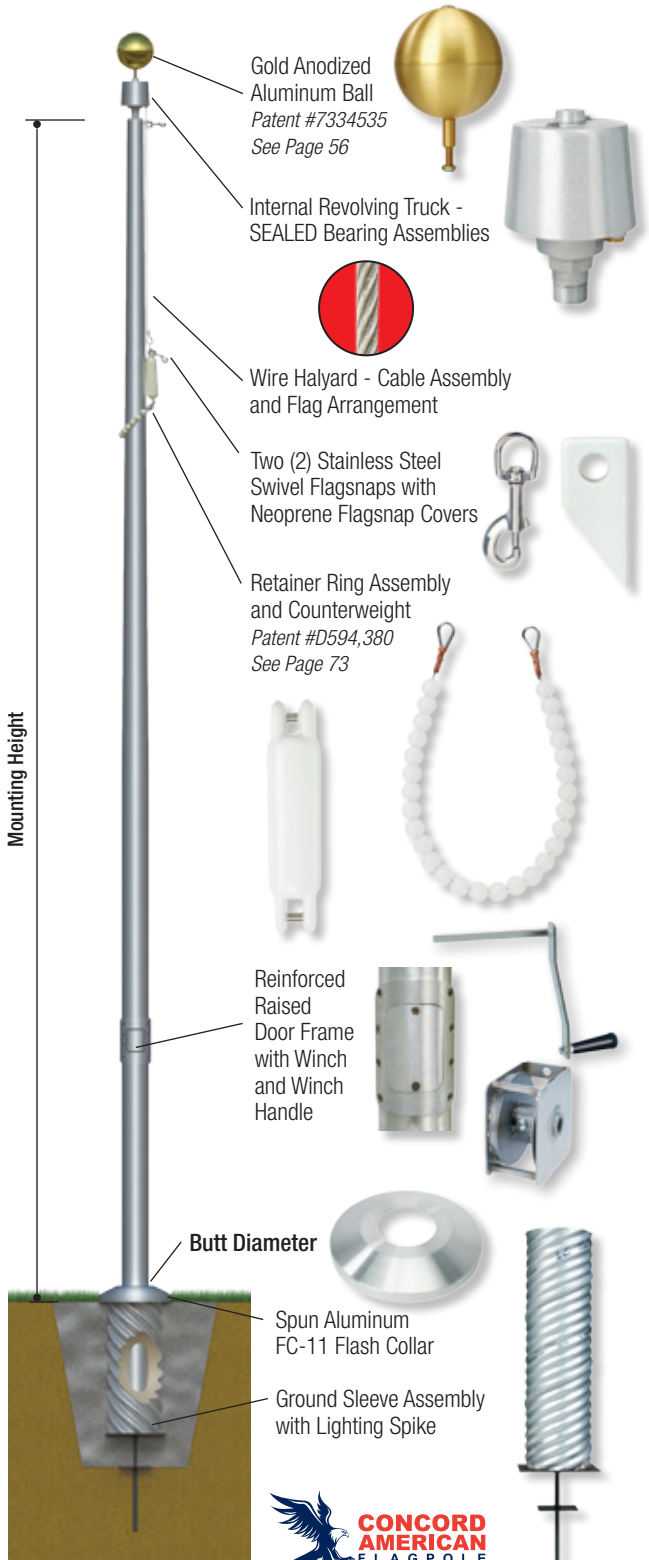

Standard Specifications

- Patented, Heavy-Duty Gold Anodized Aluminum Ball
- Cast Aluminum Revolving Truck with Dual SEALED Stainless Steel Bearing Assemblies, Aluminum Spindle, Cast Brass Exit Bushing and Removable Hood
- Complete Internal Halyard Assembly
 - Wire Halyard Cable Assembly
 - Flag Arrangement (8' x 12' and Larger Flags Include Heavy-Duty Shock Spring Assembly)
 - Two (2) Stainless Steel Swivel Flagnaps
 - Two (2) Neoprene Flagnap Covers
 - Patented, Plastic Coated Counterweight
 - Beaded Retainer Ring Assembly
- Stainless Steel Winch Assembly with Removable Hand Crank
- Reinforced Raised Door Frame
- Flush Mount Access Door with two (2) Tamper Proof Screws
- Spun Aluminum FC-11 Flash Collar
- Galvanized 16-Gauge Corrugated Steel Ground Sleeve with Steel Grounding Spike

Reinforced Raised Door Frame

Sovereignty Flagpoles are designed with a patented raised reinforced door frame consisting of a matched set of inner AND outer castings. The frame castings are attached to the flagpole shaft using a series of eight (8) tamper-proof 5/16-18NC stainless steel bolts. The aluminum door is secured with two (2) tamper-proof 1/4-20NC screws. **For additional Winch option flagpoles, see Titan IWW Flush Mount Hinged Door Design (Page 30) and Independence IRW Reinforced Welded Door Frame (Page 34).**



Patent #7717055

Sovereignty Series - ISW Internal Winch with Reinforced Raised Door Frame - Wire Halyard

MTG. HGT.	BUTT DIA.	WALL THICKNESS	POLE SECTIONS	SET DEPTH	TOP DIA.	STD. FLAG SIZE	MAX WIND SPEED WITH NYLON FLAG	MAX WIND SPEED NO FLAG	CATALOG NUMBER ***SPECIFY FINISH	FINISH			
										SATIN	CLEAR ANODIZED	DARK BRONZE OR BLACK ANODIZED	BRONZE TONE, BLACK, WHITE OR CLEAR POWDERCOAT
20'	5"	.156"	1	2'-0"	3"	4' x 6'	160	262	ISW20C51-***	\$2,273	\$2,431	\$2,512	\$2,359
	5"	.188"	1	2'-0"	3"	4' x 6'	182	287	ISW20D51-***	\$2,472	\$2,624	\$2,709	\$2,545
	6"	.156"	1	2'-0"	3.5"	4' x 6'	208	301	ISW20C61-***	\$2,663	\$2,853	\$2,901	\$2,769
	6"	.188"	1	2'-0"	3.5"	4' x 6'	229	328	ISW20D61-***	\$3,075	\$3,265	\$3,313	\$3,167
25'	5"	.156"	1	2'-6"	3"	5' x 8'	111	178	ISW25C51-***	\$2,515	\$2,716	\$2,808	\$2,635
	5"	.188"	1	2'-6"	3"	5' x 8'	124	209	ISW25D51-***	\$3,020	\$3,226	\$3,313	\$3,129
	6"	.156"	1	2'-6"	3.5"	5' x 8'	149	230	ISW25C61-***	\$2,926	\$3,165	\$3,276	\$3,070
	6"	.188"	1	2'-6"	3.5"	5' x 8'	168	253	ISW25D61-***	\$3,206	\$3,446	\$3,555	\$3,342
30'	5"	.156"	1	3'-0"	3"	6' x 10'	86	112	ISW30C51-***	\$2,685	\$2,928	\$3,023	\$2,841
	5"	.156"	2	3'-0"	3"	6' x 10'	86	112	ISW30C52-***	\$2,768	\$3,012	\$3,105	\$2,921
	5"	.188"	1	3'-0"	3"	6' x 10'	94	131	ISW30D51-***	\$3,070	\$3,314	\$3,408	\$3,215
	5"	.188"	2	3'-0"	3"	6' x 10'	94	131	ISW30D52-***	\$3,198	\$3,442	\$3,537	\$3,339
	6"	.156"	1	3'-0"	3.5"	6' x 10'	108	174	ISW30C61-***	\$3,173	\$3,455	\$3,567	\$3,351
	6"	.156"	2	3'-0"	3.5"	6' x 10'	108	174	ISW30C62-***	\$3,283	\$3,565	\$3,676	\$3,458
	6"	.188"	1	3'-0"	3.5"	6' x 10'	122	197	ISW30D61-***	\$3,310	\$3,591	\$3,704	\$3,484
	6"	.188"	2	3'-0"	3.5"	6' x 10'	122	197	ISW30D62-***	\$3,388	\$3,669	\$3,781	\$3,559
35'	5"	.156"	1	3'-6"	3"	6' x 10'	73	87	ISW35C51-***	\$2,893	\$3,174	\$3,299	\$3,079
	5"	.156"	2	3'-6"	3"	6' x 10'	73	87	ISW35C52-***	\$2,904	\$3,186	\$3,309	\$3,089
	5"	.188"	1	3'-6"	3"	6' x 10'	79	95	ISW35D51-***	\$3,359	\$3,639	\$3,763	\$3,530
	5"	.188"	2	3'-6"	3"	6' x 10'	79	95	ISW35D52-***	\$3,518	\$3,799	\$3,923	\$3,686
	6"	.156"	1	3'-6"	3.5"	6' x 10'	87	116	ISW35C61-***	\$3,333	\$3,662	\$3,814	\$3,552
	6"	.156"	2	3'-6"	3.5"	6' x 10'	87	116	ISW35C62-***	\$3,432	\$3,761	\$3,913	\$3,648
	6"	.188"	1	3'-6"	3.5"	6' x 10'	97	145	ISW35D61-***	\$3,782	\$4,112	\$4,265	\$3,989
	6"	.188"	2	3'-6"	3.5"	6' x 10'	97	145	ISW35D62-***	\$4,024	\$4,354	\$4,506	\$4,223
	7"	.156"	1	3'-6"	3.5"	6' x 10'	110	165	ISW35C71-***	\$3,744	\$4,143	\$4,305	\$4,019
	7"	.156"	2	3'-6"	3.5"	6' x 10'	110	165	ISW35C72-***	\$3,886	\$4,286	\$4,446	\$4,157
40'	7"	.188"	1	3'-6"	3.5"	6' x 10'	127	187	ISW35D71-***	\$4,090	\$4,489	\$4,650	\$4,354
	7"	.188"	2	3'-6"	3.5"	6' x 10'	127	187	ISW35D72-***	\$4,200	\$4,599	\$4,760	\$4,461
	7"	.156"	1	4'-0"	3.5"	8' x 12'	87	122	ISW40C71-***	\$4,374	\$4,810	\$4,931	\$4,666
	7"	.156"	2	4'-0"	3.5"	8' x 12'	87	122	ISW40C72-***	\$4,497	\$4,948	\$5,102	\$4,800

***** - Finish Options**

- SAT = Satin
- ACL = Anodized - Clear
- ADB = Anodized - Dark Bronze
- ABL = Anodized - Black
- BZT = Powder Coat - BronzeTone
- BLK = Powder Coat - Black
- WHT = Powder Coat - White
- CLR = Powder Coat - Clear

Quantity Discounts

5+ = 5% 8+ = 10% 15+ = 12%
 *Flagpoles From All Flagpole Series May Be Combined To Achieve Quantity Discounts.

SOVEREIGNTY SERIES - ISW OPTIONS

Cast Aluminum, SEALED Bearings, Gold Powder Coated Ball Truck.
 Replaces Standard Truck and Ball Combination - See Page 66.

8" Diameter Ball/Truck Add \$135
 10" Diameter Ball/Truck Add \$180

Cast Aluminum FC-11 In Lieu of Spun Collar - See Page 79.
 5"-7" Butt Diameters Add \$55

Flagpole Lighting Options are available for all Sovereignty Series ISW Flagpoles - See Pages 82-89.



Shoe Base Designs for Surface Mount Installations are available with all Sovereignty Series - ISW Flagpoles. See Page 14.

5" Butt Diameters Add \$210
 6"-7" Butt Diameters Add \$260

Independence Series - IRW

Internal Reinforced with Winch - Wire Halyard

The **Independence Series** from Concord American Flagpole is the perfect choice when your project calls for a commercial grade flagpole utilizing a heavy-duty Internal Halyard Winch and Wire Cable system. Offered in heights of **20' to 80'**, the reinforced welded door frame delivers exceptional strength, combining security with superior aesthetics achieved from a lockable flush mount door.

STANDARD FLAGPOLE ACCESSORIES - 6" TO 8" BUTT DIAMETERS

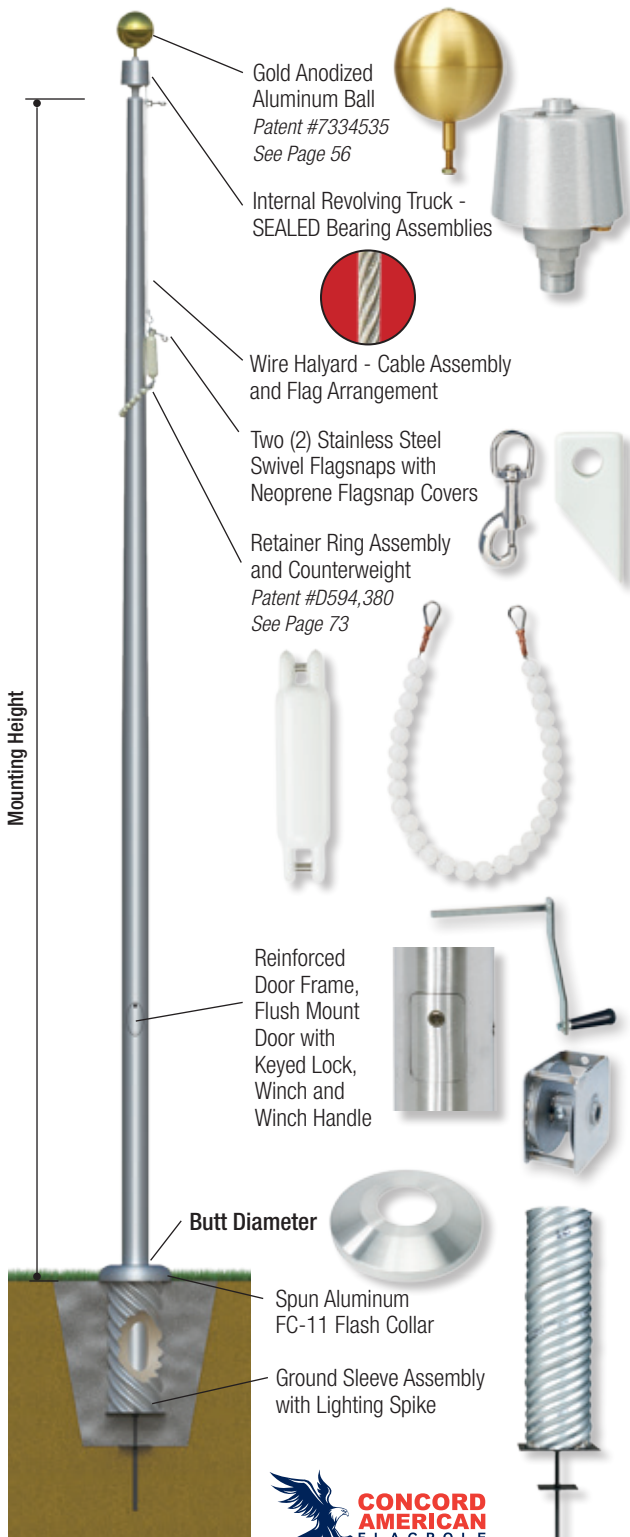

Standard Specifications

- Patented, Heavy-Duty Gold Anodized Aluminum Ball
- Cast Aluminum Revolving Truck with SEALED Stainless Steel Bearing Assemblies, Aluminum Spindle, Cast Brass Exit Bushing and Removable Hood
- Complete Internal Halyard Assembly
 - Wire Halyard Cable Assembly
 - Flag Arrangement (8' x 12' and Larger Flags Include Heavy-Duty Shock Spring Assembly)
 - Two (2) Stainless Steel Swivel Flagnaps
 - Two (2) Neoprene Flagnap Covers
 - Patented, Plastic Coated Counterweight
 - Beaded Retainer Ring Assembly
- Stainless Steel Winch Assembly with Removable Hand Crank
- Reinforced Door Frame
- Flush Mount Access Door with Lock and Keys
- Spun Aluminum FC-11 Flash Collar
- Galvanized 16-Gauge Corrugated Steel Ground Sleeve with Steel Grounding Spike

Standard Upgrades – 10" & 12" Butt Dia. 40' to 80'

- Heavy-Duty Dual SEALED Bearing Truck
- Two (2) Heavy-Duty Stainless Steel Flagnaps with Covers
- Heavy-Duty Cast Aluminum FC-11 Flash Collar
- Heavy-Duty 5/8" Ball Stem

See page 12 for 100' Flagpole Specifications.

Reinforced Welded Door Frame

Independence Flagpoles are engineered with an inset reinforced aluminum door frame welded into the precision cut door opening, providing additional strength and higher max wind speeds from each butt diameter/wall thickness combination. The efficiency of this design produces maximum strength-to-size ratios while providing a smooth, flush fitting door, making Independence IRW flagpoles the ideal choice in many applications. **For additional Winch option flagpoles, see Titan IWW Flush Mount Hinged Door Design (Page 30) and Sovereignty ISW Raised Reinforced Door Frame (Page 32).**



Independence Series - IRW Internal Reinforced with Winch - Wire Halyard

MTG. HGT.	BUTT DIA.	WALL THICKNESS	POLE SECTIONS	SET DEPTH	TOP DIA.	STD. FLAG SIZE	MAX WIND SPEED WITH NYLON FLAG	MAX WIND SPEED NO FLAG	CATALOG NUMBER ***SPECIFY FINISH	BRONZE/TONE, BLACK, WHITE OR CLEAR POWDERCOAT			
										SATIN	CLEAR ANODIZED	DARK BRONZE OR BLACK ANODIZED	BRONZE/TONE, BLACK, WHITE OR CLEAR POWDERCOAT
20'	6"	.156"	1	2'-0"	3.5"	4' x 6'	208	301	IRW20C61-***	\$3,033	\$3,230	\$3,272	\$3,133
	6"	.188"	1	2'-0"	3.5"	4' x 6'	229	328	IRW20D61-***	\$3,411	\$3,609	\$3,650	\$3,500
25'	6"	.156"	1	2'-6"	3.5"	5' x 8'	149	230	IRW25C61-***	\$3,401	\$3,648	\$3,751	\$3,539
	6"	.188"	1	2'-6"	3.5"	5' x 8'	168	253	IRW25D61-***	\$3,533	\$3,781	\$3,883	\$3,668
30'	6"	.156"	1	3'-0"	3.5"	6' x 10'	108	174	IRW30C61-***	\$3,609	\$3,900	\$4,002	\$3,783
	6"	.156"	2	3'-0"	3.5"	6' x 10'	108	174	IRW30C62-***	\$3,774	\$4,064	\$4,167	\$3,943
	6"	.188"	1	3'-0"	3.5"	6' x 10'	122	197	IRW30D61-***	\$3,907	\$4,341	\$4,300	\$4,210
	6"	.188"	2	3'-0"	3.5"	6' x 10'	122	197	IRW30D62-***	\$4,046	\$4,398	\$4,439	\$4,265
	7"	.188"	1	3'-0"	3.5"	6' x 10'	157	235	IRW30D71-***	\$4,192	\$4,656	\$4,613	\$4,517
35'	6"	.156"	1	3'-6"	3.5"	6' x 10'	87	116	IRW35C61-***	\$3,960	\$4,300	\$4,442	\$4,171
	6"	.156"	2	3'-6"	3.5"	6' x 10'	87	116	IRW35C62-***	\$4,088	\$4,430	\$4,572	\$4,296
	6"	.188"	1	3'-6"	3.5"	6' x 10'	97	145	IRW35D61-***	\$4,398	\$4,737	\$4,879	\$4,595
	6"	.188"	2	3'-6"	3.5"	6' x 10'	97	145	IRW35D62-***	\$4,600	\$4,940	\$5,082	\$4,792
	7"	.156"	1	3'-6"	3.5"	6' x 10'	110	165	IRW35C71-***	\$4,259	\$4,670	\$4,819	\$4,530
	7"	.156"	2	3'-6"	3.5"	6' x 10'	110	165	IRW35C72-***	\$4,451	\$4,862	\$5,010	\$4,716
	7"	.188"	1	3'-6"	3.5"	6' x 10'	127	187	IRW35D71-***	\$4,718	\$5,128	\$5,277	\$4,975
	7"	.188"	2	3'-6"	3.5"	6' x 10'	127	187	IRW35D72-***	\$4,882	\$5,294	\$5,442	\$5,136
40'	8"	.188"	1	3'-6"	4"	6' x 10'	155	213	IRW35D81-***	\$4,617	\$4,875	\$4,980	\$4,729
	7"	.156"	2	4'-0"	3.5"	8' x 12'	87	122	IRW40C72-***	\$4,995	\$5,462	\$5,599	\$5,297
	7"	.188"	1	4'-0"	3.5"	8' x 12'	103	147	IRW40D71-***	\$5,095	\$5,487	\$5,704	\$5,322
	8"	.156"	1	4'-0"	4"	8' x 12'	107	157	IRW40C81-***	\$4,958	\$5,363	\$5,481	\$5,202
	8"	.156"	2	4'-0"	3.5"	8' x 12'	107	157	IRW40C82-***	\$5,394	\$5,948	\$6,125	\$5,770
	8"	.188"	1	4'-0"	4"	8' x 12'	123	177	IRW40D81-***	\$5,119	\$5,538	\$5,660	\$5,373
	8"	.188"	2	4'-0"	3.5"	8' x 12'	122	177	IRW40D82-***	\$5,687	\$6,242	\$6,419	\$6,055
	8"	.250"	1	4'-0"	4"	8' x 12'	146	205	IRW40F81-***	\$5,292	\$5,726	\$5,851	\$5,554
45'	10"	.188"	1	4'-0"	3.5"	8' x 12'	166	226	IRW40D12-***	\$5,948	\$6,298	\$6,533	\$6,109
	8"	.188"	2	4'-6"	3.5"	8' x 12'	102	144	IRW45D82-***	\$6,076	\$6,653	\$6,874	\$6,453
	8"	.250"	2	4'-6"	3.5"	8' x 12'	125	173	IRW45F82-***	\$5,725	\$6,193	\$6,330	\$6,008
	10"	.188"	2	4'-6"	3.5"	8' x 12'	143	192	IRW45D12-***	\$6,312	\$6,829	\$6,979	\$6,624
50'	10"	.219"	2	4'-6"	3.5"	8' x 12'	156	208	IRW45E12-***	\$6,433	\$6,959	\$7,113	\$6,750
	8"	.188"	3	5'-0"	3.5"	10' x 15'	83	117	IRW50D83-***	\$6,274	\$6,917	\$7,178	\$6,709
	10"	.188"	3	5'-0"	4"	10' x 15'	118	164	IRW50D13-***	\$7,430	\$8,039	\$8,216	\$7,798
55'	10"	.250"	3	5'-0"	4"	10' x 15'	140	191	IRW50F13-***	\$7,484	\$8,263	\$8,582	\$8,015
	10"	.188"	3	5'-6"	4"	10' x 15'	102	139	IRW55D13-***	\$7,990	\$8,770	\$9,088	\$8,507
60'	10"	.188"	3	6'-0"	4"	12' x 18'	86	118	IRW60D13-***	\$8,422	\$9,349	\$9,702	\$9,069
	10"	.250"	3	6'-0"	4"	12' x 18'	104	143	IRW60F13-***	\$10,566	\$10,983	\$11,225	\$10,654
	10"	.312"	3	6'-0"	4"	12' x 18'	119	162	IRW60G13-***	\$10,437	\$11,364	\$11,717	\$11,023
	12"	.250"	3	6'-0"	4"	12' x 18'	137	187	IRW60F23-***	\$12,552	\$13,673	\$14,072	\$13,262
65'	10"	.312"	3	6'-6"	4"	12' x 18'	106	142	IRW65G13-***	\$11,860	\$12,980	\$13,379	\$12,591
	12"	.250"	3	6'-6"	4"	12' x 18'	122	165	IRW65F23-***	\$13,427	\$14,607	\$15,034	\$14,169
70'	10"	.312"	3	7'-0"	4"	12' x 18'	94	123	IRW70G13-***	\$12,233	\$13,354	\$13,752	\$12,953
	12"	.250"	3	7'-0"	4"	12' x 18'	109	145	IRW70F23-***	\$13,806	\$15,052	\$15,506	\$14,600
	12"	.375"	4	7'-0"	4"	12' x 18'	139	181	IRW70H24-***	\$14,123	\$15,280	\$15,616	\$14,821
75'	12"	.375"	3	7'-6"	4"	12' x 18'	126	161	IRW75H23-***	\$15,509	\$16,591	\$17,036	\$16,093
	80'	12"	.375"	3	8'-0"	4"	15' x 25'	107	144	IRW80H23-***	\$17,377	\$18,464	\$18,838
	12"	.375"	4	8'-0"	4"	15' x 25'	107	144	IRW80H24-***	\$16,979	\$18,144	\$18,547	\$17,599
100'	12"	.500"	4	10'-0"	4"	20' x 30'	90	128	IRW100I24-***	\$22,685	\$24,242	\$24,782	\$23,515

*** - Finish Options

- SAT = Satin
- ACL = Anodized - Clear
- ADB = Anodized - Dark Bronze
- ABL = Anodized - Black
- BZT = Powder Coat - Bronze/Tone
- BLK = Powder Coat - Black
- WHT = Powder Coat - White
- CLR = Powder Coat - Clear

Quantity Discounts

5+ = 5% 8+ = 10%
15+ = 12%

*Flagpoles From All Flagpole Series May Be Combined To Achieve Quantity Discounts.

INDEPENDENCE SERIES - IRW OPTIONS

Cast Aluminum, SEALED Bearings, Gold Powder Coated Ball Truck. Replaces Standard Truck and Ball Combination - See Page 66.



- 8" Diameter Ball/Truck Add \$135
- 10" Diameter Ball/Truck Add \$180
- 12" Diameter Ball/Truck Add \$325

Cast Aluminum FC-11 In Lieu of Spun Collar - See Page 79.
6"-7" Butt Diameters Add \$55
8" Butt Diameters Add \$165



Flagpole Lighting Options are available for all Independence Series IRW Flagpoles - See Pages 82-89.

Shoe Base Designs for Surface Mount Installations are available with all Independence Series - IRW Flagpoles. See Page 14.

- 6"-8" Butt Diameters . . . Add \$260
- 10" Butt Diameters Add \$520
- 12" Butt Diameters . . . Add \$1,035

***See page 12 for 100' Flagpole Specifications.**



Xtreme Series - XIWW

Xtreme Internal With Winch - Wire Halyard

The **Xtreme Series XIWW** from Concord American Flagpole provides the strength of our Xtreme Series Flush Mount Hinged Door, Internal Revolving Design in heights of 25' to 60'.



STANDARD FLAGPOLE ACCESSORIES - 7" TO 12" BUTT DIAMETERS

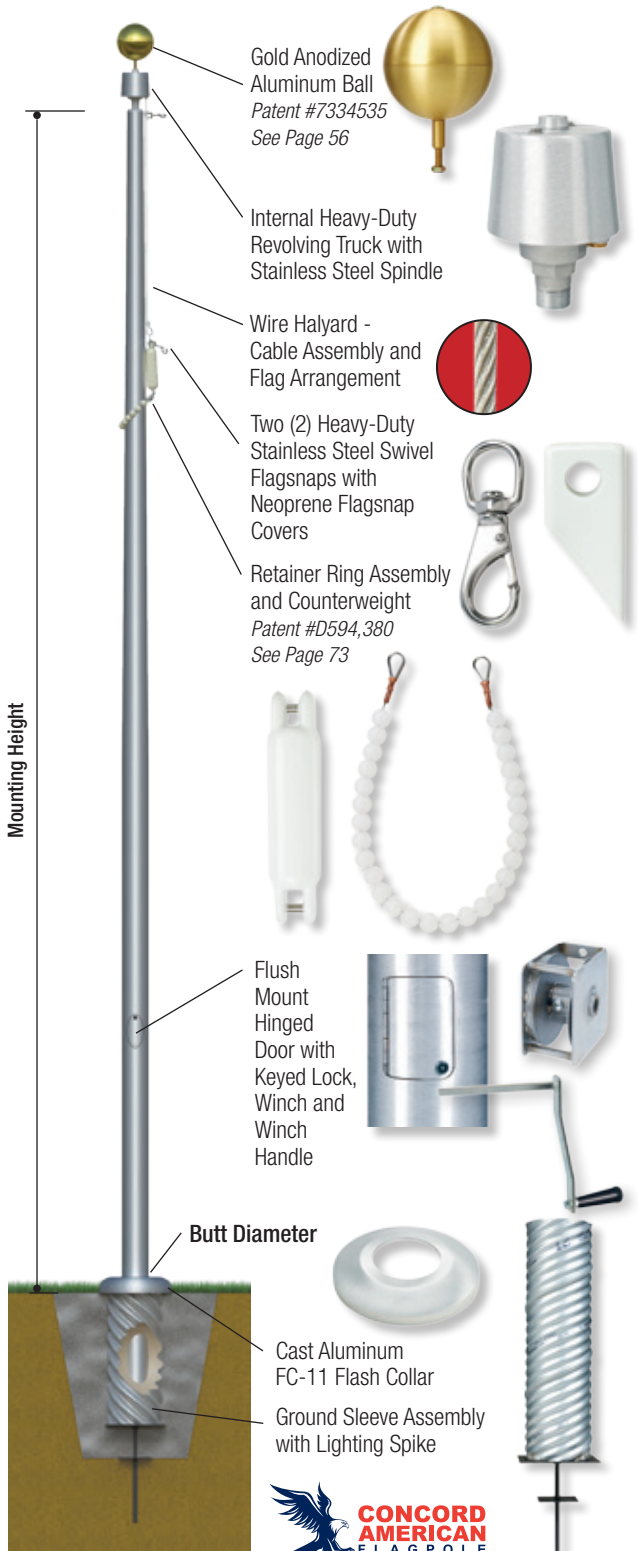

XIWW – Xtreme Internal Single Revolving

The **Xtreme Series** from Concord American Flagpole provides flagpole owners with the **Increased Wind Speed Ratings** necessary in coastal, high wind, oversized and multiple flag applications. Years of Engineering, R & D and Manufacturing experience have merged to create the strongest, most efficient increased wind speed flagpoles, combining superior strength with the highest quality **Heavy-Duty Component Parts** in the industry...Internal Revolving Trucks with SEALED Bearing Assemblies and Stainless Steel Spindle, Stainless Steel Swivel Flagsnaps and Cast Aluminum Collars.

Standard Specifications

- Patented, Heavy-Duty Gold Anodized Aluminum Ball
- Heavy-Duty Cast Aluminum Revolving Truck with SEALED Stainless Steel Bearing Assemblies, Stainless Steel Spindle, Cast Brass Exit Bushing and Removable Hood
- Complete Internal Halyard Assembly
 - Wire Halyard Cable Assembly
 - Flag Arrangement (8' x 12' and Larger Flags Include Heavy-Duty Shock Spring Assembly)
 - Two (2) Heavy-Duty Stainless Steel Swivel Flagsnaps
 - Two (2) Neoprene Flagsnap Covers
 - Patented, Plastic Coated Counterweight
 - Beaded Retainer Ring Assembly
- Stainless Steel Winch Assembly with Removable Hand Crank
- Flush Mount Access Door with Lock and Keys
- Heavy-Duty Cast Aluminum FC-11 Flash Collar
- Galvanized 16-Gauge Corrugated Steel Ground Sleeve with Steel Grounding Spike

Standard Upgrades – 10" and 12" Butt Diameters

- Heavy-Duty 5/8" Ball Stem
- Two (2) Heavy-Duty 4-1/4" Stainless Steel Flagsnaps with Covers

Flush Mount Hinged Door Design

Xtreme XIWW Flagpoles unite the simplicity of efficient engineering with the aesthetics of a precision cut, rectangular flush mount door design, providing an internal halyard Winch system that is ideal for many extreme wind speed applications. **For additional high wind speed Winch option flagpoles, see Xtreme XIRW Reinforced Welded Door Frame (Page 38).**



Xtreme Series - XIWW Internal With Winch - Wire Halyard

MTG. HGT.	BUTT DIA.	WALL THICKNESS	POLE SECTIONS	SET DEPTH	TOP DIA.	STD. FLAG SIZE	MAX WIND SPEED WITH NYLON FLAG	MAX WIND SPEED NO FLAG	CATALOG NUMBER ***SPECIFY FINISH	SATIN	CLEAR ANODIZED	DARK BRONZE OR BLACK ANODIZED	BRONZE TONE, BLACK, WHITE OR CLEAR POWDERCOAT
25'	7"	.250"	1	2'-6"	3.5"	5' x 8'	190	294	XIWW25F71-***	\$3,691	\$4,037	\$4,128	\$3,915
30'	8"	.250"	1	3'-0"	4"	6' x 10'	178	269	XIWW30F81-***	\$4,105	\$5,045	\$5,159	\$4,893
	8"	.250"	2	3'-0"	4"	6' x 10'	178	269	XIWW30F82-***	\$4,516	\$5,550	\$5,676	\$5,383
35'	8"	.312"	2	3'-6"	4"	8' x 12'	144	212	XIWW35G82-***	\$4,691	\$5,320	\$5,491	\$5,161
40'	10"	.250"	2	4'-0"	4"	8' x 12'	166	234	XIWW40F12-***	\$4,946	\$5,447	\$5,759	\$5,284
50'	12"	.250"	3	5'-0"	4"	10' x 15'	158	222	XIWW50F23-***	\$6,041	\$6,901	\$7,217	\$6,694
60'	12"	.375"	3	6'-0"	4"	12' x 18'	149	205	XIWW60H23-***	\$9,063	\$10,251	\$10,711	\$9,943

***** - Finish Options**

- SAT = Satin
- ACL = Anodized - Clear
- ADB = Anodized - Dark Bronze
- ABL = Anodized - Black
- BZT = Powder Coat - BronzeTone
- BLK = Powder Coat - Black
- WHT = Powder Coat - White
- CLR = Powder Coat - Clear

Quantity Discounts

5+ = 5% 8+ = 10% 15+ = 12%
 *Flagpoles From All Flagpole Series May Be Combined To Achieve Quantity Discounts.

Xtreme Series XIWW Options

Cast Aluminum, SEALED Bearings, Gold Powder Coated Ball Truck. Replaces Standard Truck and Ball Combination - See Page 66.

8" Diameter Ball/Truck Add \$135
 10" Diameter Ball/Truck Add \$180
 12" Diameter Ball/Truck Add \$325

Flagpole Lighting Options are available for all Xtreme Series XIWW Flagpoles - See Pages 82-89.



Shoe Base Designs for Surface Mount Installations are available with all Xtreme Series - XIWW Flagpoles. See Page 14.

- 7"-8" Butt Diameters Add \$260
- 10" Butt Diameters Add \$520
- 12" Butt Diameters Add \$1,035

Our **INDUSTRY-FIRST Lifetime Flagpole Shaft Warranty** assures that a Concord American Flagpole **Xtreme Series** Flagpole will withstand the worst Mother Nature can throw at it... **Guaranteed!**

Xtreme Series - XIRW

Xtreme Internal Reinforced with Winch - Wire Halyard

The **Xtreme Series XIRW** from Concord American Flagpole provides the strength of our Xtreme Series Reinforced Welded Door Frame, Internal Revolving Design in heights of **25' to 70'**.



XIRW – Xtreme Internal Reinforced with Winch

The **Xtreme Series** from Concord American Flagpole provides flagpole owners with the **Increased Wind Speed Ratings** necessary in coastal, high wind, oversized and multiple flag applications. Years of Engineering, R & D and Manufacturing experience have merged to create the strongest, most efficient increased wind speed flagpoles, combining superior strength with the highest quality **Heavy-Duty Component Parts** in the industry... Internal Revolving Trucks with SEALED Bearing Assemblies and Stainless Steel Spindle, Stainless Steel Swivel Flagsnaps and Cast Aluminum Collars.

STANDARD FLAGPOLE ACCESSORIES - 6" TO 12" BUTT DIAMETERS



Standard Specifications

- Patented, Heavy-Duty Gold Anodized Aluminum Ball
- Heavy-Duty Cast Aluminum Revolving Truck with SEALED Stainless Steel Bearing Assemblies, Stainless Steel Spindle, Cast Brass Exit Bushing and Removable Hood
- Complete Internal Halyard Assembly
 - Wire Halyard Cable Assembly
 - Flag Arrangement (8' x 12' and Larger Flags Include Heavy-Duty Shock Spring Assembly)
 - Two (2) Heavy-Duty Stainless Steel Swivel Flagsnaps
 - Two (2) Neoprene Flagsnap Covers
 - Patented, Plastic Coated Counterweight
 - Beaded Retainer Ring Assembly
- Stainless Steel Winch Assembly with Removable Hand Crank
- Reinforced Door Frame
- Flush Mount Access Door with Lock and Keys
- Heavy-Duty Cast Aluminum FC-11 Flash Collar
- Galvanized 16-Gauge Corrugated Steel Ground Sleeve with Steel Grounding Spike

Standard Upgrades – 10" and 12" Butt Diameters

- Heavy-Duty 5/8" Ball Stem
- Two (2) Heavy-Duty 4-1/4" Stainless Steel Flagsnaps with Covers

Reinforced Welded Door Frame

Xtreme Series XIRW Flagpoles are engineered with an inset reinforced aluminum door frame welded into the precision cut door opening, providing additional strength and higher max wind speeds from each butt diameter/ wall thickness combination. The efficiency of this design produces maximum strength-to-size ratios while providing a smooth, flush fitting door, making Xtreme XIRW flagpoles the ideal choice for the most extreme flagpole projects. **For additional high wind speed Winch option flagpoles, see Xtreme XIWW Reinforced Welded Door Frame (Page 36).**



Xtreme Series - XIRW Xtreme Internal Reinforced with Winch - Wire Halyard

MTG. HGT.	BUTT DIA.	WALL THICKNESS	POLE SECTIONS	SET DEPTH	TOP DIA.	STD. FLAG SIZE	MAX WIND SPEED WITH NYLON FLAG	MAX WIND SPEED NO FLAG	CATALOG NUMBER ***SPECIFY FINISH	SATIN	CLEAR ANODIZED	DARK BRONZE OR BLACK ANODIZED	BRONZE TONE, BLACK, WHITE OR CLEAR POWDERCOAT
25'	6"	.250"	1	2'6"	3.5"	5' x 8'	197	287	XIRW25F61-***	\$4,051	\$4,291	\$4,430	\$4,162
30'	6"	.250"	1	3'0"	3.5"	6' x 10'	150	229	XIRW30F61-***	\$4,574	\$4,851	\$4,951	\$4,705
	6"	.250"	2	3'0"	3.5"	6' x 10'	150	229	XIRW30F62-***	\$4,803	\$5,093	\$5,200	\$4,941
	7"	.188"	1	3'0"	3.5"	6' x 10'	157	235	XIRW30D71-***	\$4,131	\$4,499	\$4,509	\$4,364
	7"	.188"	2	3'0"	3.5"	6' x 10'	157	235	XIRW30D72-***	\$4,337	\$4,725	\$4,735	\$4,583
	7"	.250"	1	3'0"	3.5"	6' x 10'	194	269	XIRW30F71-***	\$4,867	\$5,010	\$5,171	\$4,860
35'	8"	.250"	1	3'6"	4"	6' x 10'	181	249	XIRW35F81-***	\$5,064	\$5,437	\$5,597	\$5,273
	8"	.250"	2	3'6"	4"	6' x 10'	181	249	XIRW35F82-***	\$5,330	\$5,709	\$5,778	\$5,537
40'	8"	.250"	2	4'0"	4"	8' x 12'	146	207	XIRW40F82-***	\$6,076	\$6,455	\$6,615	\$6,262
	10"	.250"	2	4'0"	4"	8' x 12'	192	259	XIRW40F12-***	\$6,855	\$7,388	\$7,601	\$7,166
45'	10"	.250"	2	4'6"	4"	8' x 12'	168	226	XIRW45F12-***	\$7,633	\$8,134	\$8,193	\$7,890
50'	10"	.250"	3	5'0"	4"	10' x 15'	140	191	XIRW50F13-***	\$8,129	\$8,518	\$8,885	\$8,290
	10"	.312"	3	5'0"	4"	10' x 15'	158	213	XIRW50G13-***	\$9,861	\$10,250	\$10,618	\$10,164
	12"	.250"	3	5'0"	4"	10' x 15'	179	242	XIRW50F23-***	\$9,909	\$10,298	\$10,661	\$10,174
60'	12"	.312"	3	6'0"	4"	12' x 18'	155	209	XIRW60G23-***	\$13,379	\$13,768	\$14,466	\$13,465
	12"	.375"	3	6'0"	4"	12' x 18'	171	228	XIRW60H23-***	\$14,445	\$14,834	\$15,532	\$14,562
70'	12"	.375"	3	7'0"	4"	12' x 18'	139	181	XIRW70H23-***	\$15,991	\$16,380	\$17,201	\$16,146

*** - Finish Options

- SAT = Satin
- ACL = Anodized - Clear
- ADB = Anodized - Dark Bronze
- ABL = Anodized - Black
- BZT = Powder Coat - BronzeTone
- BLK = Powder Coat - Black
- WHT = Powder Coat - White
- CLR = Powder Coat - Clear

Quantity Discounts

5+ = 5% 8+ = 10% 15+ = 12%
 *Flagpoles From All Flagpole Series May Be Combined To Achieve Quantity Discounts.

XTREME SERIES - XIRW OPTIONS

Cast Aluminum, SEALED Bearings, Gold Powder Coated Ball Truck. Replaces Standard Truck and Ball Combination - See Page 66.

8" Diameter Ball/Truck Add **\$135**
 10" Diameter Ball/Truck Add **\$180**
 12" Diameter Ball/Truck Add **\$325**

Flagpole Lighting Options are available for all Xtreme Series XESR Flagpoles - See Pages 82-89.



Shoe Base Designs for Surface Mount Installations are available with all Xtreme Series - XIRW Flagpoles. See Page 14.
 6"-8" Butt Diameters Add **\$260**
 10" Butt Diameters Add **\$520**
 12" Butt Diameters Add **\$1,035**

Our **INDUSTRY-FIRST Lifetime Flagpole Shaft Warranty** assures that a Concord American Flagpole **Xtreme Series** Flagpole will withstand the worst Mother Nature can throw at it... **Guaranteed!**

Nautical Single Mast Series - NSM

External Single Revolving with Yardarm - Rope Halyard

The **Nautical Single Mast Series** from Concord American Flagpole offers a nautical theme design incorporating a single shaft with yardarm in mounting heights from **25' to 80'**. While most popular in coastal and marine settings, the multiple halyard design is the perfect option when a multiple flag design is desired. The addition of an optional Gaff increases design possibilities.

STANDARD FLAGPOLE ACCESSORIES - 5" TO 8" BUTT DIAMETERS

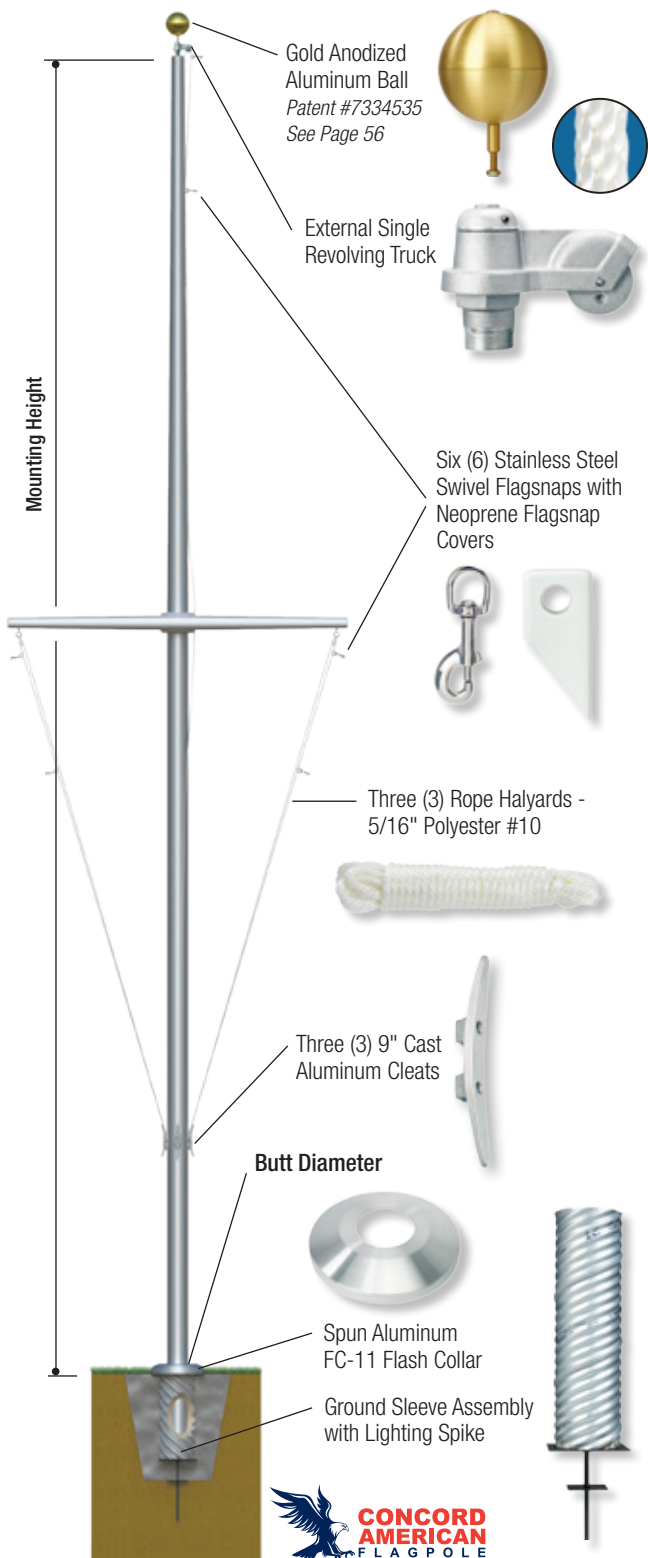

Standard Specifications

- Gold Anodized Aluminum Ball
- Cast Aluminum Single Revolving Truck Assembly with Aluminum Pulley
- Two (2) Eye Hook mounted Single Pulleys on Yardarm
- Complete External Halyard Assembly
 - Three (3) Rope Halyards - 5/16" #10 Polyester
 - Six (6) Stainless Steel Swivel Flagsnaps
 - Six (6) Neoprene Flagsnap Covers
- Three (3) 9" Heavy-Duty Aluminum Cleats
- Spun Aluminum FC-11 Flash Collar
- Galvanized 16-Gauge Corrugated Steel Ground Sleeve with Steel Grounding Spike

Standard Upgrades – 10" and 12" Butt Diameters

- Heavy-Duty Truck with Dual SEALED Bearing Assemblies
- Three (3) Rope Halyards - Heavy-Duty 3/8" #12 Polyester
- Six (6) Heavy-Duty Stainless Steel Flagsnaps with Covers
- Heavy-Duty 5/8" Ball Stem
- Heavy-Duty Cast Aluminum Collar

Nautical Single Mast Series - NSM External Single Revolving with Yardarm - Rope Halyard

MTG. HGT.	BUTT DIA.	WALL THICKNESS	POLE SECTIONS	SET DEPTH	TOP DIA.	YARDARM LENGTH	CATALOG NUMBER ***SPECIFY FINISH	CLEAR ANODIZED		DARK BRONZE OR BLACK ANODIZED	BRONZE TONE, BLACK, WHITE OR CLEAR POWDERCOAT
								SATIN			
25'	5"	.125"	1	2'6"	3"	8'0"	NSM25B51-***	\$2,132	\$2,643	\$2,537	\$2,565
	5"	.156"	1	2'6"	3"	8'0"	NSM25C51-***	\$2,399	\$2,850	\$2,957	\$2,764
	6"	.156"	1	2'6"	3"	8'0"	NSM25C61-***	\$2,804	\$3,081	\$3,198	\$2,988
30'	5"	.125"	1	3'0"	3"	8'0"	NSM30B51-***	\$2,399	\$2,675	\$2,793	\$2,596
	5"	.156"	1	3'0"	3"	8'0"	NSM30C51-***	\$2,612	\$2,889	\$3,007	\$2,803
	5"	.156"	2	3'0"	3"	8'0"	NSM30C52-***	\$2,873	\$3,177	\$3,307	\$3,082
	6"	.156"	1	3'0"	3.5"	8'0"	NSM30C61-***	\$2,910	\$3,241	\$3,369	\$3,143
	6"	.156"	2	3'0"	3.5"	8'0"	NSM30C62-***	\$3,201	\$3,565	\$3,705	\$3,458
	6"	.188"	1	3'0"	3.5"	8'0"	NSM30D61-***	\$3,007	\$3,347	\$3,465	\$3,247
35'	6"	.156"	1	3'6"	3.5"	9'6"	NSM35C61-***	\$3,220	\$3,592	\$3,742	\$3,485
	6"	.156"	2	3'6"	3.5"	9'6"	NSM35C62-***	\$3,542	\$3,952	\$4,116	\$3,834
	7"	.156"	1	3'6"	3.5"	9'6"	NSM35C71-***	\$3,390	\$3,806	\$3,976	\$3,692
	7"	.156"	2	3'6"	3.5"	9'6"	NSM35C72-***	\$3,729	\$4,187	\$4,374	\$4,060
	7"	.188"	1	3'6"	3.5"	9'6"	NSM35D71-***	\$3,731	\$4,158	\$4,318	\$4,032
	7"	.188"	2	3'6"	3.5"	9'6"	NSM35D72-***	\$4,105	\$4,574	\$4,750	\$4,436
40'	7"	.156"	1	4'0"	3.5"	10'9"	NSM40C71-***	\$4,158	\$4,626	\$4,808	\$4,488
	7"	.156"	2	4'0"	3.5"	10'9"	NSM40C72-***	\$4,574	\$5,089	\$5,289	\$4,937
	8"	.156"	1	4'0"	4"	10'9"	NSM40C81-***	\$4,425	\$4,958	\$5,171	\$4,809
	8"	.156"	2	4'0"	3.5"	10'9"	NSM40C82-***	\$4,867	\$5,452	\$5,687	\$5,289
	8"	.188"	1	4'0"	4"	10'9"	NSM40D81-***	\$4,701	\$5,224	\$5,437	\$5,067
	8"	.188"	2	4'0"	3.5"	10'9"	NSM40D82-***	\$5,172	\$5,746	\$5,980	\$5,573
50'	8"	.188"	3	5'-0"	4"	13'6"	NSM50D83-***	\$5,572	\$6,577	\$6,886	\$6,380
	10"	.188"	3	5'-0"	4"	13'6"	NSM50D13-***	\$6,533	\$7,635	\$7,958	\$7,406
60'	10"	.188"	3	6'-0"	4"	16'0"	NSM60D13-***	\$7,339	\$8,573	\$8,896	\$8,316
	10"	.250"	3	6'-0"	4"	16'0"	NSM60F13-***	\$9,095	\$10,362	\$10,684	\$10,051
	12"	.250"	3	6'-0"	4"	16'0"	NSM60F23-***	\$10,903	\$12,379	\$12,627	\$12,007
70'	10"	.312"	3	7'-0"	4"	18'9"	NSM70G13-***	\$11,137	\$12,472	\$12,780	\$12,097
	12"	.250"	3	7'-0"	4"	18'9"	NSM70F23-***	\$12,720	\$14,377	\$14,700	\$13,946
80'	12"	.375"	4	8'-0"	4"	18'9"	NSM80H24-***	\$15,958	\$17,880	\$18,203	\$17,343

*** - Finish Options

- SAT = Satin
- ACL = Anodized - Clear
- ADB = Anodized - Dark Bronze
- ABL = Anodized - Black
- BZT = Powder Coat - BronzeTone
- BLK = Powder Coat - Black
- WHT = Powder Coat - White
- CLR = Powder Coat - Clear

Quantity Discounts

5+ = 5% 8+ = 10% 15+ = 12%
 *Flagpoles From All Flagpole Series May Be Combined To Achieve Quantity Discounts.



NAUTICAL SINGLE MAST SERIES - NSM OPTIONS

Cast Aluminum, SEALED Bearings, Gold Powder Coated Ball Truck. Replaces Standard Truck and Ball Combination - See Page 63.



- 8" Diameter Ball/Truck Add \$135
- 10" Diameter Ball/Truck Add \$180
- 12" Diameter Ball/Truck Add \$325

Cast Aluminum FC-11 In Lieu of Spun Collar - See Page 79.



- 5"-7" Butt Diameters Add \$55
- 8"-12" Butt Diameters Add \$165

Flagpole Lighting Options are available for all Nautical Single Mast Series - NSM Flagpoles - See Pages 82-89.

Shoe Base Designs for Surface Mount Installations are available with all Nautical Single Mast Series - NSM Flagpoles. See Page 14.

- 5" Butt Diameters Add \$210
- 6"-8" Butt Diameters Add \$260
- 10" Butt Diameters Add \$520
- 12" Butt Diameters Add \$1,035

Gaff Options Available.
 Contact Concord American Flagpole Customer Service for sizes, specifications and pricing.



Nautical Double Mast Series - NDM

External Double Revolving with Yardarm and Gaff - Rope Halyard

The **Nautical Double Mast Series** from Concord American Flagpole uses high strength aluminum brackets to produce an offset, double shaft nautical design. Available in heights from **30' to 80'**, these flagpoles include both the yardarm and gaff, authenticating the look of the mast and rigging design from historic sailing vessels.

STANDARD FLAGPOLE ACCESSORIES - 6" TO 8" BUTT DIAMETERS

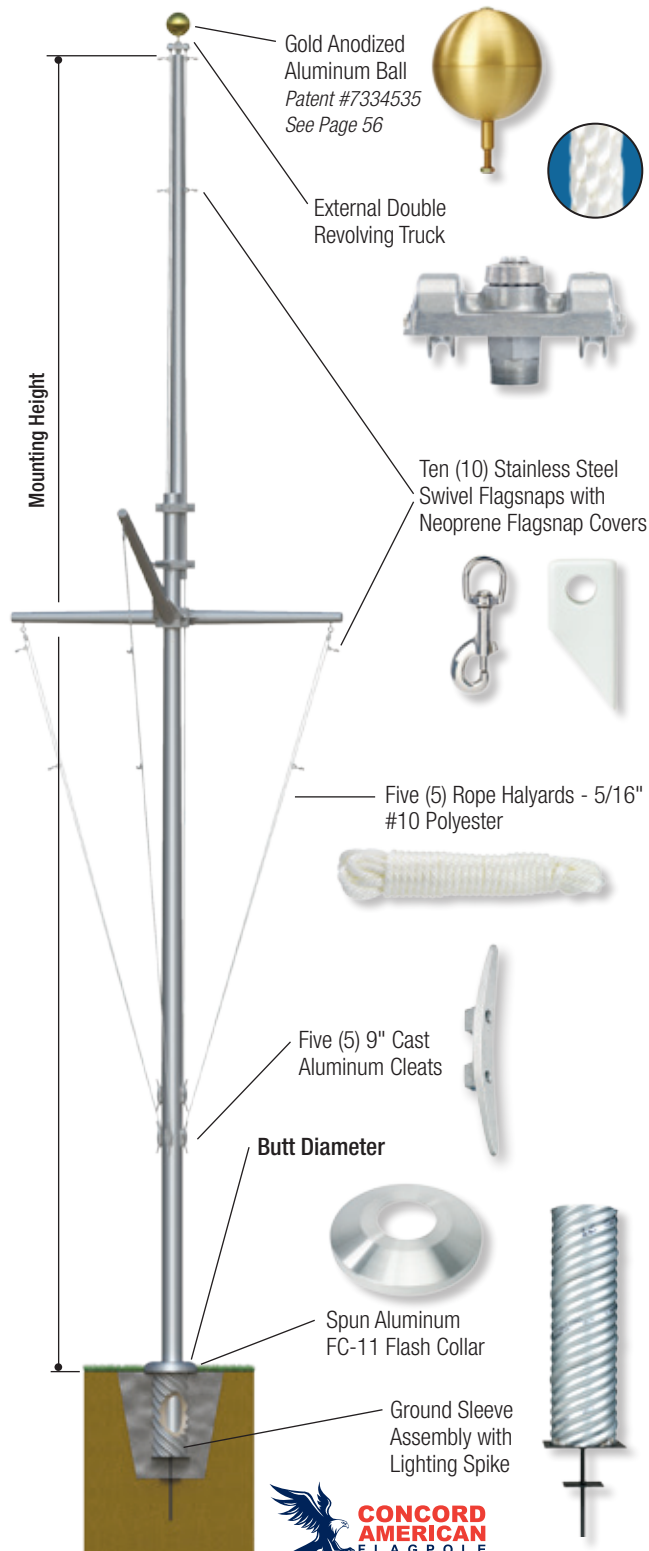

Standard Specifications

- Patented, Heavy-Duty Gold Anodized Aluminum Ball
- Cast Aluminum Double Revolving Truck Assembly with Aluminum Pulleys
- Extruded Aluminum Flagpole Bands with Stainless Steel Attaching Hardware
- Three (3) Eye Hook mounted Single Pulleys (*Yardarm and Gaff*)
- Complete External Halyard Assembly
 - Five (5) Rope Halyards - 5/16" #10 Polyester
 - Ten (10) Stainless Steel Swivel Flagsnaps
 - Ten (10) Neoprene Flagsnap Covers
- Five (5) 9" Heavy-Duty Aluminum Cleats
- Spun Aluminum FC-11 Flash Collar
- Galvanized 16-Gauge Corrugated Steel Ground Sleeve with Steel Grounding Spike

Standard Upgrades – 10" and 12" Butt Diameters

- Heavy-Duty Truck with Dual SEALED Bearing Assemblies
- Five (5) Rope Halyards - Heavy-Duty 3/8" #12 Polyester
- Ten (10) Heavy-Duty Stainless Steel Flagsnaps with Covers
- Heavy-Duty 5/8" Ball Stem
- Heavy-Duty Cast Aluminum Collar

Nautical Double Mast Series - NDM External Double Revolving with Yardarm and Gaff - Rope Halyard

MTG. HGT.	BUTT DIA.	WALL THICKNESS	POLE SECTIONS*	SET DEPTH	TOP DIA.	YARDARM LENGTH	GAFF LENGTH	CATALOG NUMBER ***SPECIFY FINISH	SATIN	CLEAR ANODIZED	DARK BRONZE OR BLACK ANODIZED	BRONZE TONE, BLACK, WHITE OR CLEAR POWDERCOAT
30'	6"	.188"	1	3'0"	3.5"	8'0"	5'0"	NDM30D61-***	\$5,437	\$5,810	\$5,885	\$5,636
	6"	.188"	2	3'0"	3.5"	8'0"	5'0"	NDM30D62-***	\$5,970	\$6,344	\$6,418	\$6,153
35'	7"	.188"	1	3'6"	3.5"	9'6"	6'0"	NDM35D71-***	\$6,354	\$6,865	\$6,972	\$6,659
	7"	.188"	2	3'6"	3.5"	9'6"	6'0"	NDM35D72-***	\$6,993	\$7,505	\$7,611	\$7,280
40'	8"	.188"	1	4'0"	4"	10'9"	7'0"	NDM40D81-***	\$7,708	\$8,305	\$8,390	\$8,055
	8"	.188"	2	4'0"	4"	10'9"	7'0"	NDM40D82-***	\$8,560	\$9,158	\$9,243	\$8,882
50'	10"	.188"	3	5'-0"	4"	13'6"	9'0"	NDM50D13-***	\$11,087	\$11,940	\$12,217	\$11,582
60'	12"	.250"	3	6'0"	4"	16'0"	10'9"	NDM60F23-***	\$17,014	\$18,165	\$18,571	\$17,621
80'	12"	.375"	4	8'0"	4"	18'9"	12'9"	NDM80H24-***	\$24,634	\$27,127	\$27,919	\$26,314

*EXCLUDES SINGLE PIECE UPPER MAST

***** - Finish Options**

- SAT = Satin
- ACL = Anodized - Clear
- ADB = Anodized - Dark Bronze
- ABL = Anodized - Black
- BZT = Powder Coat - BronzeTone
- BLK = Powder Coat - Black
- WHT = Powder Coat - White
- CLR = Powder Coat - Clear

Quantity Discounts

5+ = 5% 8+ = 10% 15+ = 12%
 *Flagpoles From All Flagpole Series May Be Combined To Achieve Quantity Discounts.

NAUTICAL DOUBLE MAST SERIES - NDM OPTIONS



Cast Aluminum FC-11
 In Lieu of Spun Collar - See Page 79.
 6"-7" Butt Diameters Add \$55
 8"-12" Butt Diameters Add \$165

Shoe Base Designs for Surface Mount Installations are available with all Nautical Double Mast Series - NDM Flagpoles. See Page 14.

- 6"-8" Butt Diameters Add \$260
- 10" Butt Diameters Add \$520
- 12" Butt Diameters Add \$1,035



Nautical Flagpoles are distinctive in their style, providing a "full sail" appearance perfect for projects requiring nautical themes, multiple flags or when restrictive sign ordinances can limit messaging opportunities.

Outrigger Wall Mount Series

External Single Stationary - Rope Halyard

The **Outrigger Single Stationary Series** from Concord American Flagpole offers wall mounted flagpole options in lengths of **6' to 20'**. A variety of Wall Mount design and angle options give project owners the ability to enhance any building facade with the customized look and beauty of aluminum flagpoles.



STANDARD FLAGPOLE ACCESSORIES

Specifications

- Patented, Heavy-Duty Gold Anodized Aluminum Ball
- Cast Aluminum Single Stationary Truck Assembly with Aluminum Pulley
- Complete External Halyard Assembly
 - Rope Halyard - 5/16" #10 Polyester
 - Two (2) Solid Brass Swivel Flagnaps
 - Two (2) Neoprene Flagnap Covers
- 9" Cast Aluminum Cleat
- 3/8" Eyebolt and Double Swivel Pulley
- Anchorage by Others

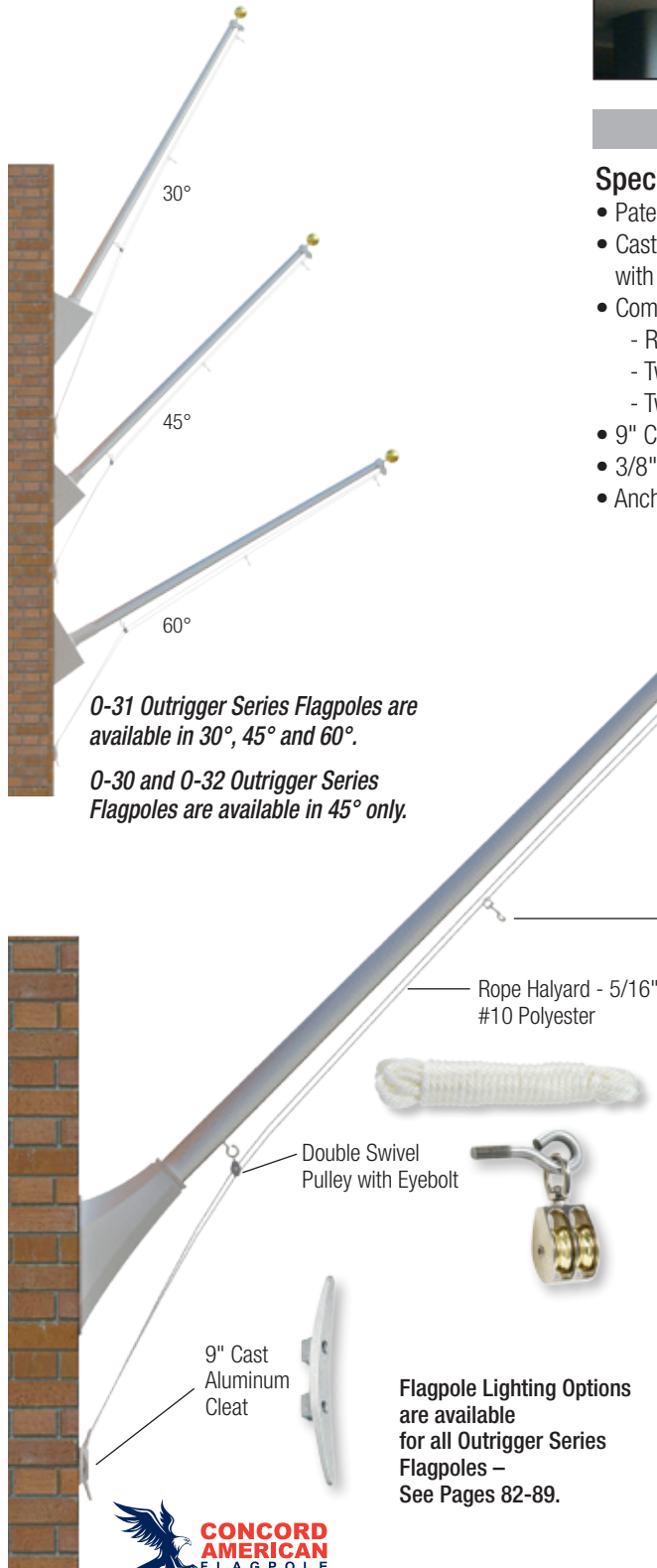

0-31 Outrigger Series Flagpoles are available in 30°, 45° and 60°.

0-30 and 0-32 Outrigger Series Flagpoles are available in 45° only.

Flagpole Lighting Options are available for all Outrigger Series Flagpoles – See Pages 82-89.



0-30
45° Arm Angle
4 Bolt Design

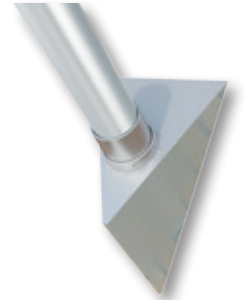

0-31
30°, 45°, 60°
Arm Angle
3 Bolt Design



0-32
45° Arm Angle
4 Bolt Design



OUTRIGGER SERIES OPTIONS	
Cap Mounted Style Single Revolving Truck In Lieu Of Standard Stationary Truck. <i>See Page 62</i> Add \$55	Cleat Cover (Specify Cylinder Lock or Padlock) - <i>See Page 75.</i> Cleat Cover Add \$130
Outrigger Retainer System. Pulley Shown. <i>See Page 81 for full System details.</i> Outrigger Retainer System . . . Add \$55	Wall Anchorage Kit. Contains one Sleeve, one Bolt, Washers and Nuts. Offered as component pieces only for 0-31 and 0-32. <i>See NOTE on page 81.</i> WAK-9421 Add \$55 / Ea.



Outrigger Wall Mount Series External Single Stationary - Rope Halyard

0-30 - 45°

DESCRIPTION	NOMINAL OVERALL LENGTH	BUTT DIA.	WALL THICKNESS	POLE SECTIONS	TOP DIA.	CATALOG NUMBER ***SPECIFY FINISH	SATIN	CLEAR ANODIZED	DARK BRONZE OR BLACK ANODIZED	BRONZETONE BLACK, WHITE OR CLEAR POWDER COAT
						0-30 - 45°				
0-30 - 45° Arm Angle - Straight Shaft	8'	3"	.125"	1	3"	030-08B34-***	\$469	\$518	\$528	\$502
0-30 - 45° Arm Angle - Straight Shaft	10'	3"	.125"	1	3"	030-10B34-***	\$501	\$549	\$560	\$533
0-30 - 45° BRACKET ONLY	-	3"	-	-	-	BKT-0304-***	\$183	-	-	\$220

0-31 - 30° / 45° / 60°

DESCRIPTION	NOMINAL OVERALL LENGTH	BUTT DIA.	WALL THICKNESS	POLE SECTIONS	TOP DIA.	CATALOG NUMBER ***SPECIFY FINISH	SATIN	CLEAR ANODIZED	DARK BRONZE OR BLACK ANODIZED	BRONZETONE BLACK, WHITE OR CLEAR POWDER COAT
						0-31 - 30°				
0-31 - 30° Arm Angle - Tapered Shaft	6'	4"	.125"	1	2.5"	031-06B43-***	\$1,151	\$1,216	\$1,260	\$1,180
0-31 - 30° Arm Angle - Tapered Shaft	8'	4"	.125"	1	2.5"	031-08B43-***	\$1,180	\$1,260	\$1,290	\$1,222
0-31 - 30° Arm Angle - Tapered Shaft	10'	4"	.125"	1	2.5"	031-10B43-***	\$1,333	\$1,433	\$1,487	\$1,391
0-31 - 30° Arm Angle - Tapered Shaft	12'	4"	.156"	1	2.5"	031-12C43-***	\$1,333	\$1,433	\$1,487	\$1,391
0-31 - 30° Arm Angle - Tapered Shaft	15'	4"	.188"	1	2.5"	031-15D43-***	\$1,353	\$1,481	\$1,538	\$1,437
0-31 - 30° Arm Angle - Tapered Shaft	18'	4"	.188"	1	2.5"	031-18D43-***	\$1,683	\$1,905	\$1,979	\$1,847
0-31 - 30° Arm Angle - Tapered Shaft	20'	4"	.188"	1	2.5"	031-20D43-***	\$1,813	\$2,037	\$2,125	\$1,976
0-31 - 30° BRACKET ONLY	-	4"	-	-	-	BKT-0313-***	\$816	-	-	\$941
						0-31 - 45°				
0-31 - 45° Arm Angle - Tapered Shaft	6'	4"	.125"	1	2.5"	031-06B44-***	\$1,151	\$1,216	\$1,260	\$1,180
0-31 - 45° Arm Angle - Tapered Shaft	8'	4"	.125"	1	2.5"	031-08B44-***	\$1,180	\$1,260	\$1,290	\$1,222
0-31 - 45° Arm Angle - Tapered Shaft	10'	4"	.125"	1	2.5"	031-10B44-***	\$1,333	\$1,433	\$1,487	\$1,391
0-31 - 45° Arm Angle - Tapered Shaft	12'	4"	.156"	1	2.5"	031-12C44-***	\$1,333	\$1,433	\$1,487	\$1,391
0-31 - 45° Arm Angle - Tapered Shaft	15'	4"	.188"	1	2.5"	031-15D44-***	\$1,353	\$1,481	\$1,538	\$1,437
0-31 - 45° Arm Angle - Tapered Shaft	18'	4"	.188"	1	2.5"	031-18D44-***	\$1,683	\$1,905	\$1,979	\$1,847
0-31 - 45° Arm Angle - Tapered Shaft	20'	4"	.188"	1	2.5"	031-20D44-***	\$1,813	\$2,037	\$2,125	\$1,976
0-31 - 45° BRACKET ONLY	-	4"	-	-	-	BKT-0314-***	\$816	-	-	\$941
						0-31 - 60°				
0-31 - 60° Arm Angle - Tapered Shaft	6'	4"	.125"	1	2.5"	031-06B46-***	\$1,151	\$1,216	\$1,260	\$1,180
0-31 - 60° Arm Angle - Tapered Shaft	8'	4"	.125"	1	2.5"	031-08B46-***	\$1,180	\$1,260	\$1,290	\$1,222
0-31 - 60° Arm Angle - Tapered Shaft	10'	4"	.125"	1	2.5"	031-10B46-***	\$1,333	\$1,433	\$1,487	\$1,391
0-31 - 60° Arm Angle - Tapered Shaft	12'	4"	.156"	1	2.5"	031-12C46-***	\$1,333	\$1,433	\$1,487	\$1,391
0-31 - 60° Arm Angle - Tapered Shaft	15'	4"	.188"	1	2.5"	031-15D46-***	\$1,353	\$1,481	\$1,538	\$1,437
0-31 - 60° Arm Angle - Tapered Shaft	18'	4"	.188"	1	2.5"	031-18D46-***	\$1,683	\$1,905	\$1,979	\$1,847
0-31 - 60° Arm Angle - Tapered Shaft	20'	4"	.188"	1	2.5"	031-20D46-***	\$1,813	\$2,037	\$2,125	\$1,976
0-31 - 60° BRACKET ONLY	-	4"	-	-	-	BKT-0316-***	\$816	-	-	\$941

0-32 - 45°

DESCRIPTION	NOMINAL OVERALL LENGTH	BUTT DIA.	WALL THICKNESS	POLE SECTIONS	TOP DIA.	CATALOG NUMBER ***SPECIFY FINISH	SATIN	CLEAR ANODIZED	DARK BRONZE OR BLACK ANODIZED	BRONZETONE BLACK, WHITE OR CLEAR POWDER COAT
						0-32 - 45°				
0-32 - 45° Arm Angle - Tapered Shaft	6'	4"	.125"	1	2.5"	032-06B44-***	\$1,453	\$1,538	\$1,568	\$1,492
0-32 - 45° Arm Angle - Tapered Shaft	8'	4"	.125"	1	2.5"	032-08B44-***	\$1,540	\$1,621	\$1,679	\$1,572
0-32 - 45° Arm Angle - Tapered Shaft	10'	4"	.125"	1	2.5"	032-10B44-***	\$1,647	\$1,760	\$1,802	\$1,707
0-32 - 45° Arm Angle - Tapered Shaft	12'	4"	.156"	1	2.5"	032-12C44-***	\$1,647	\$1,760	\$1,802	\$1,707
0-32 - 45° Arm Angle - Tapered Shaft	15'	4"	.188"	1	2.5"	032-15D44-***	\$1,655	\$1,803	\$1,876	\$1,748
0-32 - 45° Arm Angle - Tapered Shaft	18'	4"	.188"	1	2.5"	032-18D44-***	\$2,072	\$2,285	\$2,375	\$2,217
0-32 - 45° Arm Angle - Tapered Shaft	20'	4"	.188"	1	2.5"	032-20D44-***	\$2,143	\$2,388	\$2,478	\$2,316
0-32 - 45° BRACKET ONLY	-	4"	-	-	-	BKT-0324-***	\$1,333	-	-	\$1,492

***** - Finish Options**

- SAT = Satin
- ACL = Anodized - Clear
- ADB = Anodized - Dark Bronze
- ABL = Anodized - Black
- BZT = Powder Coat - BronzeTone
- BLK = Powder Coat - Black
- WHT = Powder Coat - White
- CLR = Powder Coat - Clear

Quantity Discounts

- 5+ = 5%
- 8+ = 10%
- 15+ = 12%
- *Flagpoles From All Flagpole Series May Be Combined To Achieve Quantity Discounts.

NOTE: Cast Brackets Must Be Powder Coated. Due to the color variances between Anodized & Powder Coat finishes, it is recommended that Vertical Wall Mount Flagpoles be Powder Coated.



Vertical Wall Mount Series

External Single Revolving and Single Stationary - Rope Halyard

The **Vertical Wall Mount Series** from Concord American Flagpole provides commercial-grade, one and two-piece solid aluminum Wall Mount designs in **3" to 6"** butt diameters in standard heights of **12' to 38.5'**. Flagpole heights listed are maximum heights for each shaft listed. All shafts can be modified to shorter heights upon request.



STANDARD FLAGPOLE ACCESSORIES - 3" TO 6" BUTT DIAMETERS

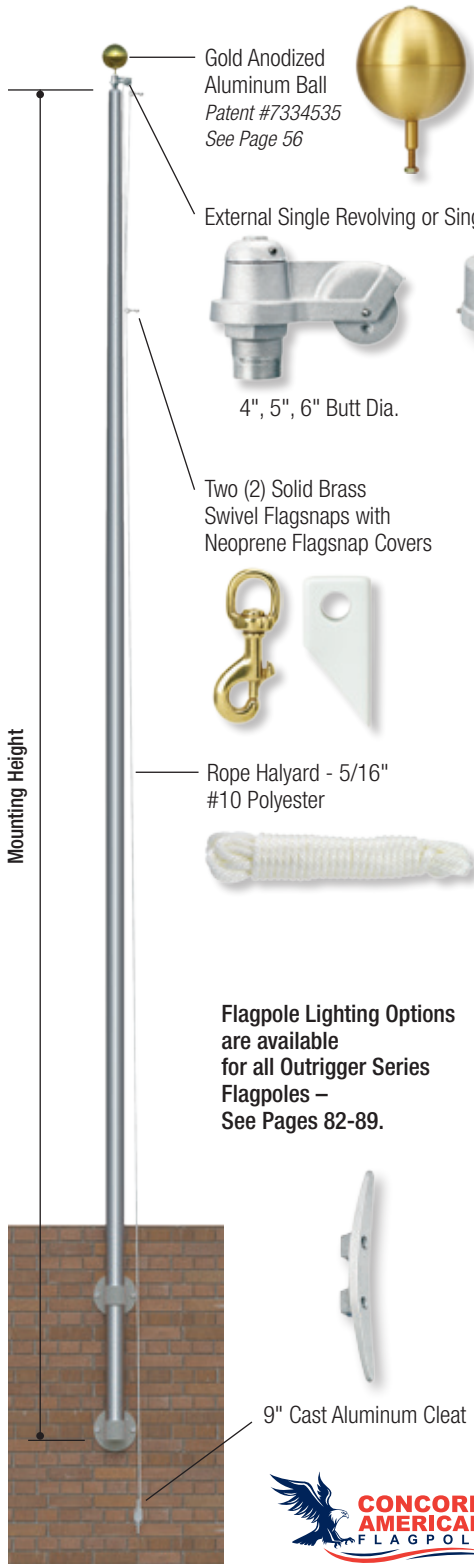

Gold Anodized Aluminum Ball
Patent #7334535
See Page 56

External Single Revolving or Single Stationary Truck



Two (2) Solid Brass Swivel Flagnaps with Neoprene Flagnap Covers



Rope Halyard - 5/16" #10 Polyester



Flagpole Lighting Options are available for all Outrigger Series Flagpoles - See Pages 82-89.



9" Cast Aluminum Cleat



Specifications

- Patented, Heavy-Duty Gold Anodized Aluminum Ball
- Cast Aluminum Single Revolving (4", 5", and 6" Butt Dia.) or Single Stationary (3" Butt Dia.) Truck Assembly with Aluminum Pulley.
- Complete External Halyard Assembly
 - Rope Halyard - 5/16" #10 Polyester
 - Two (2) Solid Brass Swivel Snap Hooks
 - Two (2) Neoprene Snap Hook Covers
- 9" Cast Aluminum Cleat
- Anchorage by Others

VERTICAL WALL MOUNT SERIES OPTIONS

Cast Aluminum, SEALED Bearings, Gold Powder Painted Ball Truck. Replaces Standard Truck and Ball Combination - See Page 63.



8" Diameter Ball/Truck Add **\$135**
10" Diameter Ball/Truck Add **\$180**

Double Revolving System (Double Truck, Extra Cleat and Complete Double Halyard Assembly) - Specify EDR (External Double Revolving). See Page 61 Add **\$55**



Cleat Cover (Specify Cylinder Lock or Padlock) - See Page 75.



Cleat Cover Add **\$130**

Wall Anchorage Kit. Contains one Sleeve, one Bolt, Washers and Nuts. Offered as component pieces only. See NOTE on page 81.



WAK-9421 Add **\$55 / Ea.**

Bracket Only

DESCRIPTION	CATALOG NUMBER ***SPECIFY FINISH	SATIN	BRONZE TONE BLACK, WHITE OR CLEAR POWDER COAT
VW-1 Bracket 3"	VW1-0003-***	\$278	\$314
VW-1 Bracket 4"	VW1-0004-***	\$614	\$652
VW-1 Bracket 5"	VW1-0005-***	\$614	\$652
VW-1 Bracket 6"	VW1-0006-***	\$614	\$652
VW-2 Bracket 4"	VW2-0004-***	\$853	\$962
VW-2 Bracket 5"	VW2-0005-***	\$924	\$1,033
VW-2 Bracket 6"	VW2-0006-***	\$924	\$1,033
VW-3 Bracket 4"	VW3-0004-***	\$348	\$403
VW-3 Bracket 5"	VW3-0005-***	\$359	\$413
VW-3 Bracket 6"	VW3-0006-***	\$381	\$435
VW-8 Bracket 4"	VW8-0004-***	\$570	\$625
VW-8 Bracket 5"	VW8-0005-***	\$581	\$634
VW-8 Bracket 6"	VW8-0006-***	\$591	\$646
VW-9 Bracket 4"	VW9-0004-***	\$604	\$658
VW-9 Bracket 5"	VW9-0005-***	\$620	\$674
VW-9 Bracket 6"	VW9-0006-***	\$636	\$690

NOTE: Cast Brackets Must Be Powder Coated. Due to the color variances between Anodized & Powder Coat finishes, it is recommended that Vertical Wall Mount Flagpoles be Powder Coated.



VW-1
4 Bolt Design



VW-2
3 Bolt Design



VW-3
4 Bolt Design



VW-8
3 Bolt Design



VW-9
4 Bolt Design

Vertical Wall Mount Series External Single Revolving and Single Stationary - Rope Halyard

DESCRIPTION	NOMINAL OVERALL LENGTH	BUTT DIA.	WALL THICKNESS	POLE SECTIONS	TOP DIA.	CATALOG NUMBER ***SPECIFY FINISH	SATIN	CLEAR ANODIZED	DARK BRONZE OR BLACK ANODIZED	BRONZETONE
										BLACK, WHITE OR CLEAR POWDER COAT
VSS-1 - Straight Shaft - Stationary	12'	3"	.125"	1	3"	VSS1-12B31-***	\$469	\$523	\$533	\$507
VSS-1 - Straight Shaft - Stationary	15'	3"	.125"	1	3"	VSS1-15B31-***	\$496	\$543	\$549	\$528

DESCRIPTION	NOMINAL OVERALL LENGTH	BUTT DIA.	WALL THICKNESS	POLE SECTIONS	TOP DIA.	CATALOG NUMBER ***SPECIFY FINISH	SATIN	CLEAR ANODIZED	DARK BRONZE OR BLACK ANODIZED	BRONZETONE
										BLACK, WHITE OR CLEAR POWDER COAT
VTS-1 - Tapered Shaft - Stationary	12'	3"	.125"	1	2"	VTS1-12B31-***	\$565	\$624	\$661	\$604
VTS-1 - Tapered Shaft - Stationary	15'	3"	.125"	1	2"	VTS1-15B31-***	\$677	\$741	\$751	\$718
VTS-1 - Tapered Shaft - Stationary	20'	3"	.125"	1	2"	VTS1-20B31-***	\$773	\$885	\$917	\$858
VTS-1 - Tapered Shaft - Stationary	25'	3"	.125"	1	2"	VTS1-25B31-***	\$885	\$1,034	\$1,066	\$1,003
VTR-1 - Tapered Shaft - Revolving	15'	4"	.125"	1	3"	VTR1-15B41-***	\$1,349	\$1,442	\$1,504	\$1,398
VTR-1 - Tapered Shaft - Revolving	20'	4"	.125"	1	3"	VTR1-20B41-***	\$1,440	\$1,642	\$1,701	\$1,593
VTR-1 - Tapered Shaft - Revolving	25'	5"	.156"	1	3"	VTR1-25C51-***	\$1,971	\$2,213	\$2,301	\$2,147
VTR-1 - Tapered Shaft - Revolving	30'	6"	.156"	1	3.5"	VTR1-30C61-***	\$2,447	\$2,800	\$2,917	\$2,716
VTR-1 - Tapered Shaft - Revolving	30'	6"	.188"	1	3.5"	VTR1-30D61-***	\$2,620	\$2,932	\$3,063	\$2,844
VTR-1 - Tapered Shaft - Revolving	35'	6"	.188"	1	3.5"	VTR1-35D61-***	\$3,057	\$3,421	\$3,519	\$3,318

DESCRIPTION	NOMINAL OVERALL LENGTH	BUTT DIA.	WALL THICKNESS	POLE SECTIONS	TOP DIA.	CATALOG NUMBER ***SPECIFY FINISH	SATIN	CLEAR ANODIZED	DARK BRONZE OR BLACK ANODIZED	BRONZETONE
										BLACK, WHITE OR CLEAR POWDER COAT
VTR-2 - Tapered Shaft - Revolving	15'	4"	.125"	1	3"	VTR2-15B41-***	\$1,593	\$1,703	\$1,756	\$1,652
VTR-2 - Tapered Shaft - Revolving	20'	4"	.125"	1	3"	VTR2-20B41-***	\$1,842	\$2,052	\$2,110	\$1,990
VTR-2 - Tapered Shaft - Revolving	25'	5"	.156"	1	3"	VTR2-25C51-***	\$2,460	\$2,829	\$2,887	\$2,744
VTR-2 - Tapered Shaft - Revolving	30'	6"	.156"	1	3.5"	VTR2-30C61-***	\$3,079	\$3,605	\$3,693	\$3,497
VTR-2 - Tapered Shaft - Revolving	30'	6"	.188"	1	3.5"	VTR2-30D61-***	\$3,540	\$4,075	\$4,235	\$3,953
VTR-2 - Tapered Shaft - Revolving	35'	6"	.188"	1	3.5"	VTR2-35D61-***	\$4,159	\$4,646	\$4,822	\$4,506

DESCRIPTION	NOMINAL OVERALL LENGTH	BUTT DIA.	WALL THICKNESS	POLE SECTIONS	TOP DIA.	CATALOG NUMBER ***SPECIFY FINISH	SATIN	CLEAR ANODIZED	DARK BRONZE OR BLACK ANODIZED	BRONZETONE
										BLACK, WHITE OR CLEAR POWDER COAT
VTR-3 - Tapered Shaft - Revolving	15'	4"	.125"	1	3"	VTR3-15B41-***	\$1,349	\$1,460	\$1,491	\$1,417
VTR-3 - Tapered Shaft - Revolving	20'	4"	.125"	1	3"	VTR3-20B41-***	\$1,440	\$1,642	\$1,701	\$1,593
VTR-3 - Tapered Shaft - Revolving	25'	5"	.156"	1	3"	VTR3-25C51-***	\$1,971	\$2,213	\$2,301	\$2,147
VTR-3 - Tapered Shaft - Revolving	30'	6"	.156"	1	3.5"	VTR3-30C61-***	\$2,447	\$2,800	\$2,917	\$2,716
VTR-3 - Tapered Shaft - Revolving	30'	6"	.188"	1	3.5"	VTR3-30D61-***	\$2,620	\$2,932	\$3,063	\$2,844
VTR-3 - Tapered Shaft - Revolving	35'	6"	.188"	1	3.5"	VTR3-35D61-***	\$2,778	\$2,917	\$3,048	\$2,830

DESCRIPTION	NOMINAL OVERALL LENGTH	BUTT DIA.	WALL THICKNESS	POLE SECTIONS	TOP DIA.	CATALOG NUMBER ***SPECIFY FINISH	SATIN	CLEAR ANODIZED	DARK BRONZE OR BLACK ANODIZED	BRONZETONE
										BLACK, WHITE OR CLEAR POWDER COAT
VTR-8 - Tapered Shaft - Revolving	15'	4"	.125"	1	3"	VTR8-15B41-***	\$2,747	\$2,899	\$2,917	\$2,812
VTR-8 - Tapered Shaft - Revolving	20'	4"	.125"	1	3"	VTR8-20B41-***	\$3,094	\$3,328	\$3,371	\$3,227
VTR-8 - Tapered Shaft - Revolving	25'	5"	.156"	1	3"	VTR8-25C51-***	\$3,842	\$4,235	\$4,324	\$4,108
VTR-8 - Tapered Shaft - Revolving	30'	6"	.156"	1	3.5"	VTR8-30C61-***	\$4,057	\$4,616	\$4,733	\$4,477
VTR-8 - Tapered Shaft - Revolving	30'	6"	.188"	1	3.5"	VTR8-30D61-***	\$4,705	\$5,275	\$5,423	\$5,118
VTR-8 - Tapered Shaft - Revolving	35'	6"	.188"	1	3.5"	VTR8-35D61-***	\$5,166	\$5,643	\$5,818	\$5,473

DESCRIPTION	NOMINAL OVERALL LENGTH	BUTT DIA.	WALL THICKNESS	POLE SECTIONS	TOP DIA.	CATALOG NUMBER ***SPECIFY FINISH	SATIN	CLEAR ANODIZED	DARK BRONZE OR BLACK ANODIZED	BRONZETONE
										BLACK, WHITE OR CLEAR POWDER COAT
VTR-9 - Tapered Shaft - Revolving	15'	4"	.125"	1	3"	VTR9-15B41-***	\$2,903	\$3,052	\$3,305	\$2,960
VTR-9 - Tapered Shaft - Revolving	20'	4"	.125"	1	3"	VTR9-20B41-***	\$3,237	\$3,488	\$3,531	\$3,383
VTR-9 - Tapered Shaft - Revolving	25'	5"	.156"	1	3"	VTR9-25C51-***	\$4,000	\$4,397	\$4,485	\$4,264
VTR-9 - Tapered Shaft - Revolving	30'	6"	.156"	1	3.5"	VTR9-30C61-***	\$4,217	\$4,763	\$4,896	\$4,620
VTR-9 - Tapered Shaft - Revolving	30'	6"	.188"	1	3.5"	VTR9-30D61-***	\$4,863	\$5,423	\$5,584	\$5,260
VTR-9 - Tapered Shaft - Revolving	35'	6"	.188"	1	3.5"	VTR9-35D61-***	\$5,324	\$5,803	\$5,979	\$5,629

*** - Finish Options
 SAT = Satin
 ACL = Anodized - Clear
 ADB = Anodized - Dark Bronze
 ABL = Anodized - Black
 BZT = Powder Coat - BronzeTone
 BLK = Powder Coat - Black
 WHT = Powder Coat - White
 CLR = Powder Coat - Clear

Quantity Discounts 5+ = 5% 8+ = 10% 15+12%
 *Flagpoles From All Flagpole Series May Be Combined To Achieve Quantity Discounts.



Internal Vertical Wall Mount Series - VIC

Internal Cam Cleat - Rope Halyard

The **Internal Halyard Vertical Wall Mount Series** brings the security of Concord American Flagpole's Sentry Series to a Vertical Wall Mount, Cam Cleat design. This design provides a more aesthetic appearance to the installed flagpole by replacing the external Rope Halyard and Cleat associated with standard external Wall Mount installations.

STANDARD FLAGPOLE ACCESSORIES - 5" TO 5.5" BUTT DIAMETERS



Specifications -

- 5" to 5.5" Butt Diameters
- Patented, Heavy-Duty Gold Anodized Aluminum Ball
- Cast Aluminum Revolving Truck with SEALED Stainless Steel Bearing Assemblies, Aluminum Spindle, Cast Brass Exit Bushing and Removable Hood
- Complete External Halyard Assembly
 - Rope Halyard - 5/16" #10 Wire Center Polyester
 - Flag Arrangement (8' x 12' Flags and Above with Heavy-Duty Shock Spring Assembly)
 - Two (2) Stainless Steel Swivel Flagsnaps with Neoprene Flagsnap Covers
 - Patented, Plastic Coated Counterweight
 - Two (2) Beaded Retainer Ring Assemblies
- Cam Cleat
- Reinforced Rasied Door Frame
- Flush Mount Access Door with Lock and Keys

VIC Options

Ball Truck (See Page 66) and Flagpole Lighting Options (See Pages 82-89).

The **Internal Vertical Wall Mount Cam Cleat Series** mounts the **Cam Cleat** assembly in the lower bracket rather than in the flagpole shaft, allowing for easy access to the **Internal Rope Halyard System**. The flagpole shaft slides through the upper bracket and into the lower bracket, resting upon an internally welded ring above the Cam Cleat assembly. Both the upper and lower aluminum bracket assemblies are designed with dual mounting plates that provide a total of 8 attachment bolts for maximum attachment strength. Set screws in both brackets secure the pole into place. The flagpole is equipped with the highest quality component parts matching those of our popular Sentry Series. A second Retainer Ring Assembly and Connecting Link for use at the top of the flag is included to assist in lowering the flag to the top of the upper bracket.

Internal Vertical Wall Mount Series - VIC Internal Cam Cleat - Rope Halyard

NOMINAL OVERALL LENGTH	DESCRIPTION	BUTT DIA.	WALL THICKNESS	POLE SECTIONS	TOP DIA.	CATALOG NUMBER ***SPECIFY FINISH	SATIN	CLEAR ANODIZED	DARK BRONZE OR BLACK ANODIZED	BRONZETONE BLACK, WHITE OR CLEAR POWDER COAT
20'	VIC Internal Halyard - Cam Cleat	5"	.188"	1	3"	VIC20D51-***	\$2,234	\$2,442	\$2,506	\$2,368
25'	VIC Internal Halyard - Cam Cleat	5"	.188"	1	3"	VIC25D51-***	\$2,506	\$2,734	\$2,846	\$2,653
30'	VIC Internal Halyard - Cam Cleat	5"	.188"	1	3"	VIC30D51-***	\$2,787	\$3,022	\$3,124	\$2,931

Quantity Discounts 5+ = 5% 8+ = 10% 15+12%
*Flagpoles From All Flagpole Series May Be Combined To Achieve Quantity Discounts.

NOTE: Cast Brackets Must Be Powder Coated. Due to the color variances between Anodized & Powder Coat finishes, it is recommended that Vertical Wall Mount Flagpoles be Powder Coated.



Internal Vertical Wall Mount Series - VIW Internal Winch - Wire Halyard

The **Internal Halyard Vertical Wall Mount Winch Series** incorporates Concord American Flagpole's Winch and Wire Cable System used in our Independence Series into a Vertical Wall Mount design. The security provided by this Winch system combines the perfect solution to vandalism with the clean lines and aesthetics obtained with an Internal Halyard flagpole.

STANDARD FLAGPOLE ACCESSORIES - 5" TO 5.5" BUTT DIAMETERS

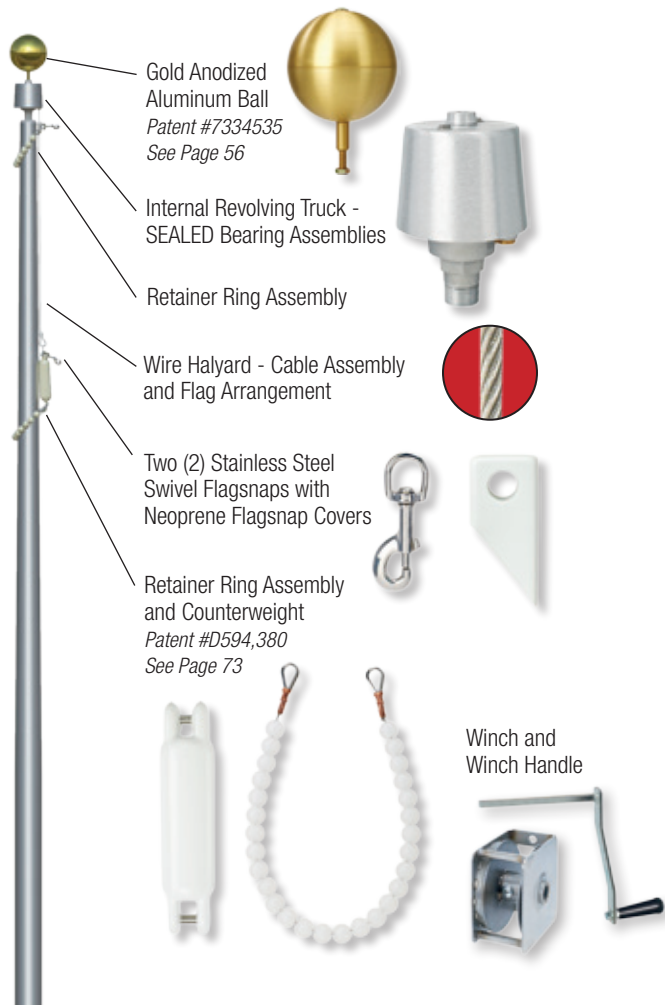

Specifications -

- 5" to 5.5" Butt Diameters
- Patented, Heavy-Duty Gold Anodized Aluminum Ball
- Cast Aluminum Revolving Truck with SEALED Stainless Steel Bearing Assemblies, Aluminum Spindle, Cast Brass Exit Bushing and Removable Hood
- Complete Internal Halyard Assembly
 - Wire Halyard Cable Assembly
 - Flag Arrangement (8' x 12' Flags and Above with Heavy-Duty Shock Spring Assembly)
 - Two (2) Stainless Steel Swivel Flagnaps with Neoprene Flagnap Covers
 - Patented, Plastic Coated Counterweight
 - Two (2) Beaded Retainer Ring Assemblies
- Stainless Steel Winch Assembly with Removable Hand Crank

VIW Options

Ball Truck (See Page 66) and Flagpole Lighting Options (See Pages 82-89).

The **Internal Vertical Wall Mount Winch Series** is designed with the Winch attached to a platform installed into the bottom of the lower bracket. The flagpole shaft slides through the upper bracket and into the lower bracket, resting upon an internally welded ring above the winch assembly. The Winch and platform can be removed for maintenance by removing the tamperproof mounting screw. Both aluminum bracket assemblies are designed with dual mounting plates that provide a total of 8 attachment bolts for maximum attachment strength. Set screws secure the pole into place. The flagpole is equipped with the highest quality component parts matching those of our popular Independence Series. A second Retainer Ring Assembly and Connecting Link for use at the top of the flag is included to assist in lowering the flag to the top of the upper bracket.

Internal Vertical Wall Mount Series - VIW Internal Winch - Wire Halyard

NOMINAL OVERALL LENGTH	DESCRIPTION	BUTT DIA.	WALL THICKNESS	POLE SECTIONS	TOP DIA.	CATALOG NUMBER ***SPECIFY FINISH	FINISH		BRONZE TONE	
							SATIN	CLEAR ANODIZED	DARK BRONZE OR BLACK ANODIZED	BLACK, WHITE OR CLEAR POWDER COAT
20'	VIW Internal Halyard - Winch	5"	.188"	1	3"	VIW20D51-***	\$2,878	\$3,097	\$3,156	\$3,004
25'	VIW Internal Halyard - Winch	5"	.188"	1	3"	VIW25D51-***	\$3,076	\$3,337	\$3,443	\$3,236
30'	VIW Internal Halyard - Winch	5"	.188"	1	3"	VIW30D51-***	\$3,449	\$3,672	\$3,779	\$3,562

Quantity Discounts 5+ = 5% 8+ = 10% 15+12%
*Flagpoles From All Flagpole Series May Be Combined To Achieve Quantity Discounts.

NOTE: Cast Brackets Must Be Powder Coated. Due to the color variances between Anodized & Powder Coat finishes, it is recommended that Vertical Wall Mount Flagpoles be Powder Coated.



American Tradition Flagpole Kit

Commercial-Grade Tapered Aluminum Flagpole Kit

The American Tradition Flagpole Kit is the industry's premiere Flagpole Kit. Manufactured in our facility to exacting specifications, this kit contains all of the Concord American Flagpole quality seen in our standard offering, providing the highest-quality, longest-lasting flagpole kit in the industry.

- **6063 Aluminum Alloy**
Seamless, commercial grade aluminum alloy.
- **3 Tapered Sections**
Cone Tapered sections are manufactured to precise tolerances for easy and attractive installations.
- **Satin Aluminum Finish**
A natural aluminum finish that will never rust.
- **Heavy-Duty Components**
The same standard components used on our Courtyard ESS commercial series flagpoles.
- **Shipped Complete with all Accessories and Ground Sleeve**
All components necessary for a long lasting, permanent installation. *(Flags sold separately - see Pages 54-55).*
- **FED EX and UPS Shippable**

The American Tradition's sturdy .125" Aluminum Wall Construction delivers superior strength and longevity in an easy-to-assemble kit.



Manufactured In
USA

American Tradition Flagpole Kit

MTG. HEIGHT	DESCRIPTION	BUTT DIA.	WALL THICKNESS	POLE SECTIONS	TOP DIA.	CATALOG NUMBER ***SPECIFY FINISH	SATIN	DARK BRONZE, BLACK, WHITE, OR CLEAR POWDER COAT
20'	American Tradition Flagpole Kit	3"	0.125"	3	2"	ATK20B33-***	\$533	\$642
25'	American Tradition Flagpole Kit	3"	0.125"	4	2"	ATK25B34-***	\$670	\$802

Quantity Discount: 5+ Deduct 5%. 10+ Deduct 10%.

*** - Specify Finish
SAT = Satin
BZT = Bronze Tone Powder Coat
BLK = Black Powder Coat
WHT = White Powder Coat

Standard Features

- 20' Mounting Height (22' Overall Height)
- Full 3" Butt Diameter
- 3" Gold Anodized Ball Ornament
- Cast Aluminum Single Stationary Truck Assembly with Aluminum Pulley
- Complete External Halyard Assembly
 - Rope Halyard - #10 Polyester
 - Two Chrome Plated Bronze Snap Hooks
- 6" Cleat with Attaching Screws
- Clear Silicone Adhesive Sealant
- PVC Foundation Sleeve

Options

- Cap Style Revolving Truck Assembly *(See Page 62)*...Add **\$42**
- Stationary Ball Truck *(2" Only - See Page 63)*...Add **\$20**
- Spun Aluminum Collar *(See Page 78)*...Add **\$36**



ATK20B33-***





American Elite Telescoping Flagpole

Commercial-Grade With "Easy Lock" Construction

The American Elite is the industry's highest quality, commercial-grade telescoping flagpole. Designed with both residential and light commercial users in mind, the multiple design patents provide the industry's longest-lasting and easiest to install telescoping flagpole. Our unique "Easy Lock" system provides users the ability to quickly raise and lower the flagpole while the "Swivel Ring System" allows the flag to rotate freely. Available in 20' and 25'.

- **6000 Series Aluminum Shafts**
30% stronger than many competitor's telescoping flagpoles.
- **Patented "Easy Lock" System**
Extends quickly and easily, securely locking each section in place. No arrows to line up or hard pins to push. Full extension in seconds.
- **Swivel Ring System**
An aesthetic, quiet, and tangle-free system with no hardware to bang against the pole or rope halyard to wear or tangle.
- **Clear Anodized Aluminum Finish**
An architectural-grade anodized aluminum finish that will never rust.
- **Shipped Complete with Accessories and U.S. Flag**
Includes all components necessary for proper installation.
- **FED EX and UPS Shippable**

COMING SPRING 2019...

Contact Concord American Flagpole Customer Service for more information.



Standard Features

- **"Easy Lock" System (Patented)**
- Split Ring Swivels constructed of Lexan polycarbonate with UV blockers
- High Strength Aluminum Alloy 6000 Series with T6 Temper
- Clear Anodized Aluminum Finish
- Maintenance-Free
- Portable
- Seven (7) Year Shaft Warranty
- One (1) Year Accessory Warranty

Flagpole Kit Includes the Following:

- Telescoping Flagpole Shaft
- Swivel Rings With Flagsnaps to Fly One or Two Flags
- Additional Swivel Ring to Fly One Flag at Half Mast
- Ground Sleeve
- Gold Ball Finial
- 3' X 5' U.S. Nylon Flag, Double Stitched with Embroidered Stars



Patio Flagpole Kits

Residential Non-Tapered Aluminum Flagpole Kits

The lightweight yet strong PATIO Series offers an excellent value in a beautiful, non-tapered modular flagpole that makes the perfect choice for the home or small business.

Standard Features

- 20' and 25' Mounting Heights
- 2" and 2.5" Butt Diameters
- 6063 Aluminum Alloy
- 3" Gold Anodized Ball Ornament
- Cast Aluminum Single Stationary Truck
- Polyester Rope Halyard
- Nylon Flagnaps
- Plated Cleat
- PVC Foundation Sleeve
- Heavy-Wall Shipping and Storage Tube
- Fed Ex and UPS Shippable

Options

- Cap Style Revolving Truck Assembly (See Page 62)...Add **\$42**
- Stationary Ball Truck (2" Only - See Page 63)...Add **\$20**
- Never-Furl™ Assembly (2" Only - In lieu of truck, halyard, cleat and flagnaps)...**No Charge**
- Spun Aluminum Collar (See Page 78)...Add **\$36**

***** - Specify Finish**

ACL = Anodized - Clear
WHT = White

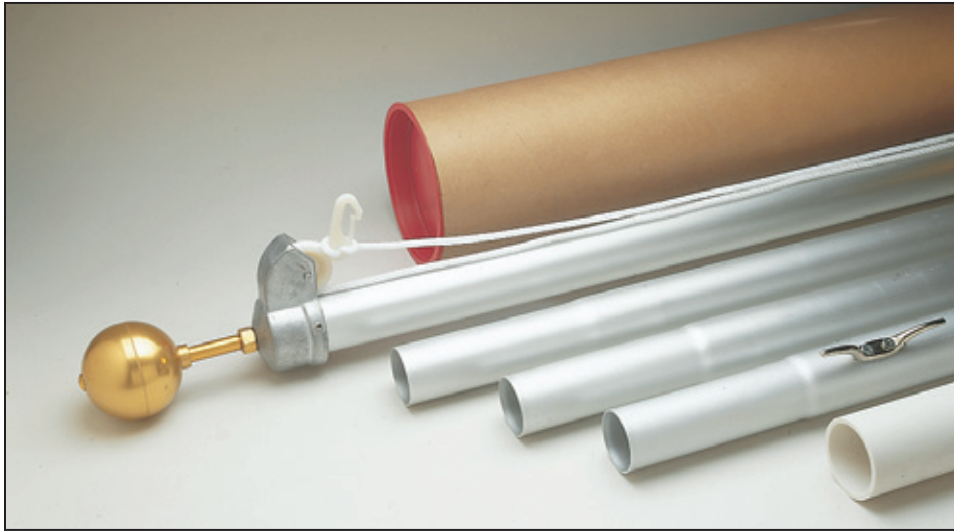

Patio Flagpole Kits

MTG. HEIGHT	DESCRIPTION	BUTT DIA.	WALL THICKNESS	POLE SECTIONS	TOP DIA.	CATALOG NUMBER ***SPECIFY FINISH	CLEAR ANODIZED	WHITE POWDER COAT
10'	Patio Non-Tapered Flagpole Kit	2"	0.0625"	2	2"	PAT10PB2-***	\$138	\$141
15'	Patio Non-Tapered Flagpole Kit	2"	0.0625"	3	2"	PAT15PB3-***	\$156	\$160
20'	Patio Non-Tapered Flagpole Kit	2"	0.0625"	4	2"	PAT20PB4-***	\$185	\$191
	Patio Non-Tapered Flagpole Kit	2.5"	0.0650"	5	2.5"	PAT20PD5-***	\$267	\$273
25'	Patio Non-Tapered Flagpole Kit	2.5"	0.0650"	6	2.5"	PAT25PD6-***	\$293	\$300

Quantity Discount: 5+ Deduct 5%. 10+ Deduct 10%. Quantities may be combined.

Never-Furl™ Assembly

Patio Flagpoles can also be fitted with the popular NeverFurl™ rotating system. The NeverFurl™ system replaces the truck assembly, cleat, halyard and flag snaps, providing a clean, quiet, and tangle-free flagpole system. The provided 3" Diameter Ball screws into a fitted plug that fits into the top of the flagpole to retain a finished flagpole appearance.

Never-Furl™ Assembly

The Never-Furl™ Assembly can be substituted in lieu of the truck, halyard, cleat and flagnaps on any PATIO flagpole at **NO CHARGE**.

TRK-8400 (sold Separately)...\$16



Part No. TRK-8400



Patio Wall Mount Kits

Outrigger and Vertical



Standard Features

- 6063 Aluminum Alloy
- 3" Gold Anodized Ball Ornament
- Cast Aluminum Single Stationary Truck
- Polyester Rope Halyard
- Nylon Flagnaps
- Plated Cleat (OP-5 Only)
- Fed Ex and UPS Shippable

Options

- Cap Style Revolving Truck Assembly (See Page 62)...Add **\$42**
- Stationary Ball Truck (2" Only - See Page 63)...Add **\$20**
- Never-Furl™ Assembly - See Page 52 (2" Only - In lieu of truck, halyard, cleat and flagnaps)...**No Charge**
- Spun Aluminum Collar (See Page 78)...Add **\$36**



*** - Specify Finish
 ACL = Anodized - Clear
 WHT = White

Patio Outrigger Wall Mount Flagpole Kit With One Cast Aluminum Bracket

NOMINAL OVERALL LENGTH	DESCRIPTION	BUTT DIA.	WALL THICKNESS	POLE SECTIONS	TOP DIA.	CATALOG NUMBER ***SPECIFY FINISH	CLEAR ANODIZED	WHITE POWDER COAT
						OP-5 Bracket		
6'	OP-5 Bracket - 45° Arm Angle	2"	.0625"	1	2"	OP506PB4-***	\$166	\$173
12'	OP-5 Bracket - 45° Arm Angle	2"	.0625"	1	2"	OP512PB4-***	\$208	\$221
-	OP-5 - 45° BRACKET ONLY	2"	-	-	-	BKT-OP54-***	\$114	\$120
						OP-6 Bracket		
6'	OP-6 Bracket - 30° Arm Angle	2"	.0625"	1	2"	OP606PB3-***	\$135	\$152
6'	OP-6 Bracket - 45° Arm Angle	2"	.0625"	1	2"	OP606PB4-***	\$135	\$152
-	OP-6 - 30° BRACKET ONLY	2"	-	-	-	BKT-OP63-***	\$83	\$89
-	OP-6 - 45° BRACKET ONLY	2"	-	-	-	BKT-OP64-***	\$83	\$89

Quantity Discount: 5+ Deduct 5%. 10+ Deduct 10%. Quantities may be combined. Brackets are Powder Coated.

Patio Vertical Wall Mount Flagpole Kit With Two Cast Aluminum Brackets

NOMINAL OVERALL HEIGHT	DESCRIPTION	BUTT DIA.	WALL THICKNESS	POLE SECTIONS	TOP DIA.	CATALOG NUMBER ***SPECIFY FINISH	CLEAR ANODIZED	WHITE POWDER COAT
						VP-1 Bracket		
6'	VP-1 Bracket	2"	.062"	1	2"	VP106PB0-***	\$166	\$173
12'	VP-1 Bracket	2"	.062"	1	2"	VP112PB0-***	\$211	\$225
-	VP-1 BRACKET ONLY	2"	-	-	-	BKT-VP10-***	\$124	\$130

Quantity Discount: 5+ Deduct 5%. 10+ Deduct 10%. Quantities may be combined. Brackets are Powder Coated.





US Flags

Flags from Concord American Flagpole are manufactured from today's most advanced, highest quality materials utilizing advanced technologies and stitching techniques. All labor and materials are certified...

"100% Made in the USA"



Nylon Flags

Our most popular flag, Nylon flags are produced from weather resistant premium nylon fabric chosen for maximum beauty and fly-ability.

- The perfect combination of strength, beauty and lightweight material allow nylon flags to fly in the slightest of breezes.
- UV protective technologies provide rich, vibrant colors that are protected from the sun's harmful rays.
- Precision embroidered White Stars (*sewn Appliqué Stars on larger flag sizes*).
- A combination of Chain stitching on horizontal seams and Lock stitching on all edge hems provide the longest lasting flag durability.

Polyester Flags

Polyester flags are produced from a premium, tear-resistant spun polyester fabric that provides maximum durability. The strong, yet lightweight, woven material combines maximum strength and fly-ability.

- 2-Ply construction provides extended flag life in the toughest of outdoor environments.
- Lock stitched reinforced seams.

Note: *Flagpole Wind Speeds found in the Flagpole family tables are calculated with a Nylon flag and cannot be used when a Polyester flag is preferred. Refer to Pages 90-92 Flagpole Wind Speed for wind speed information when using Polyester Flags.*

NYLON					POLYESTER			
SIZE	DESCRIPTION	PART NUMBER	1+	6+	DESCRIPTION	PART NUMBER	1+	6+
2' x 3'	US Flag - Nylon	FLG-0203N-US	\$26	\$25	-	-	-	-
3' x 5'	US Flag - Nylon	FLG-0305N-US	\$39	\$36	US Flag - Polyester - 2-Ply	FLG-0305P-US	\$46	\$42
4' x 6'	US Flag - Nylon	FLG-0406N-US	\$47	\$46	US Flag - Polyester - 2-Ply	FLG-0406P-US	\$67	\$62
5' x 8'	US Flag - Nylon	FLG-0508N-US	\$74	\$70	US Flag - Polyester - 2-Ply	FLG-0508P-US	\$105	\$94
6' x 10'	US Flag - Nylon	FLG-0610N-US	\$105	\$100	US Flag - Polyester - 2-Ply	FLG-0610P-US	\$164	\$152
8' x 12'	US Flag - Nylon	FLG-0812N-US	\$195	\$187	US Flag - Polyester - 2-Ply	FLG-0812P-US	\$261	\$250
10' x 15'	US Flag - Nylon	FLG-1015N-US	\$298	\$285	US Flag - Polyester - 2-Ply	FLG-1015P-US	\$391	\$381
12' x 18'	US Flag - Nylon	FLG-1218N-US	\$399	\$386	US Flag - Polyester - 2-Ply	FLG-1218P-US	\$490	\$468
15' x 25'	US Flag - Nylon	FLG-1525N-US	\$688	\$674	US Flag - Polyester - 2-Ply	FLG-1525P-US	\$869	\$837
20' x 30'	US Flag - Nylon	FLG-2030N-US	\$920	\$869	US Flag - Polyester - 2-Ply	FLG-2030P-US	\$1,250	\$1,207
20' x 38'	US Flag - Nylon	FLG-2038N-US	\$1,082	\$1,033	US Flag - Polyester - 2-Ply	FLG-2038P-US	\$1,478	\$1,424
30' x 50'	US Flag - Nylon	FLG-3050N-US	\$2,001	\$1,913	US Flag - Polyester - 2-Ply	FLG-3050P-US	\$3,113	\$3,054
30' x 60'	US Flag - Nylon	FLG-3060N-US	\$2,379	\$2,282	US Flag - Polyester - 2-Ply	FLG-3060P-US	\$3,250	\$3,152

Texas Flags – Large Sizes

Constructed of the highest quality materials, these Large Size Texas Flags are offered in both Nylon and Polyester options in sizes to 30' x 60'. See Page 55 for standard size Texas flags.



NYLON					POLYESTER		
SIZE	DESCRIPTION	PART NUMBER	1+	6+	PART NUMBER	1+	6+
6' x 10'	Texas State Flag	FLG-0610N-TX	\$114	\$112	FLG-0610-TX	\$160	\$157
8' x 12'	Texas State Flag	FLG-0812N-TX	\$185	\$181	FLG-0812P-TX	\$229	\$224
10' x 15'	Texas State Flag	FLG-1015N-TX	\$302	\$296	FLG-1015P-TX	\$359	\$352
12' x 18'	Texas State Flag	FLG-1218N-TX	\$411	\$403	FLG-1218P-TX	\$498	\$487
15' x 25'	Texas State Flag	FLG-1525N-TX	\$541	\$530	FLG-1525P-TX	\$693	\$680
20' x 30'	Texas State Flag	FLG-2030N-TX	\$921	\$904	FLG-2030P-TX	\$1,195	\$1,172
20' x 38'	Texas State Flag	FLG-2038N-TX	\$989	\$969	FLG-2038P-TX	\$1,326	\$1,299
30' x 60'	Texas State Flag	FLG-3060N-TX	\$1,902	\$1,864	FLG-3060P-TX	\$2,500	\$2,450

Military Flags

The official flags of our Nation's finest, these quality Nylon Military Flags are available for every branch of our US Military as well as a POW-MIA option. Support Our Troops!

Military Flag Part Number Example:
FLG-0406N-USMC
 4' X 6' Nylon Marine Corps Flag

Part Number (Branch) Options
USAF = Air Force
ARMY = Army
USCG = Coast Guard
USMC = Marine Corps
NAVY = Navy

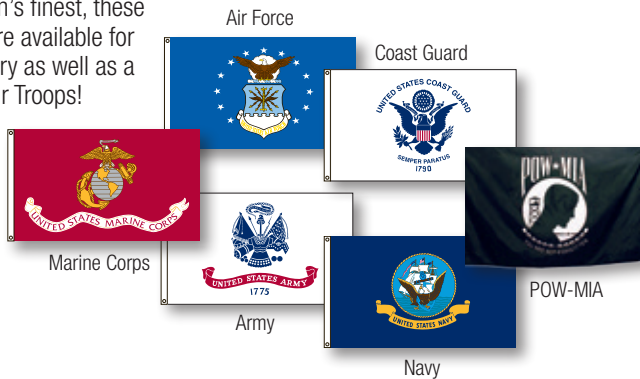

NYLON				
SIZE	DESCRIPTION	PART NUMBER	1+	6+
MILITARY				
2' x 3'	Military Flag	FLG-0203N-(BRANCH)	\$40	\$39
3' x 5'	Military Flag	FLG-0305N-(BRANCH)	\$41	\$40
4' x 6'	Military Flag	FLG-0406N-(BRANCH)	\$93	\$91
5' x 8'	Military Flag	FLG-0508N-(BRANCH)	\$130	\$127
6' x 10'	Military Flag	FLG-0610N-(BRANCH)	\$301	\$295
POW-MIA				
2' x 3'	POW Flag	FLG-0203N-POW	\$30	\$29
3' x 5'	POW Flag	FLG-0305N-POW	\$39	\$38
4' x 6'	POW Flag	FLG-0406N-POW	\$61	\$59
5' x 8'	POW Flag	FLG-0508N-POW	\$92	\$90
6' x 10'	POW Flag	FLG-0610N-POW	\$279	\$274

Christian Flag

Our Christian Flag is produced in a sewn Nylon construction.



NYLON				
SIZE	DESCRIPTION	PART NUMBER	1+	6+
3' x 5'	Christian Flag	FLG-0305N-CHR	\$67	\$65
4' x 6'	Christian Flag	FLG-0406N-CHR	\$99	\$97
5' x 8'	Christian Flag	FLG-0508N-CHR	\$145	\$142
6' x 10'	Christian Flag	FLG-0610N-CHR	\$449	\$440



State Flags

Constructed of the highest quality fabric, our State Flags are unsurpassed in elegance and craftsmanship. Specifically engineered for outdoor use, the intricate flag design of each of our 50 States is reproduced to exacting specifications.

"100% Made in the USA"

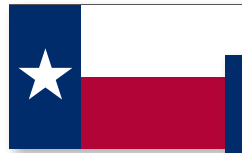

Texas (TX)



Virginia (VA)

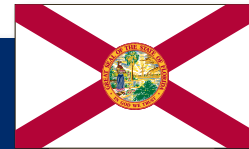

Florida (FL)



Iowa (IA)

STATE FLAG	ABV	PART NUMBER	NYLON								POLYESTER						
			0305N 3' x 5'		0406N 4' x 6'		0508N 5' x 8'		0610N 6' x 10'		0305P 3' x 5'		0406P 4' x 6'		0508P 5' x 8'		
			1+	6+	1+	6+	1+	6+	1+	6+	PART NUMBER	1+	6+	1+	6+	1+	6+
Alabama	AL	FLG-"Size"-AL	\$42	\$41	\$72	\$70	\$99	\$97	\$205	\$201	FLG-"Size"-AL	\$61	\$60	\$92	\$90	\$127	\$125
Alaska	AK	FLG-"Size"-AK	\$42	\$41	\$72	\$70	\$99	\$97	\$205	\$201	FLG-"Size"-AK	\$61	\$60	\$92	\$90	\$127	\$125
Arizona	AZ	FLG-"Size"-AR	\$42	\$41	\$72	\$70	\$99	\$97	\$205	\$201	FLG-"Size"-AR	\$61	\$60	\$92	\$90	\$127	\$125
Arkansas	AR	FLG-"Size"-AZ	\$42	\$41	\$72	\$70	\$99	\$97	\$205	\$201	FLG-"Size"-AZ	\$61	\$60	\$92	\$90	\$127	\$125
California	CA	FLG-"Size"-CA	\$42	\$41	\$72	\$70	\$99	\$97	\$205	\$201	FLG-"Size"-CA	\$61	\$60	\$92	\$90	\$127	\$125
Colorado	CO	FLG-"Size"-CO	\$42	\$41	\$72	\$70	\$99	\$97	\$205	\$201	FLG-"Size"-CO	\$61	\$60	\$92	\$90	\$127	\$125
Connecticut	CT	FLG-"Size"-CT	\$42	\$41	\$81	\$79	\$126	\$123	\$205	\$224	FLG-"Size"-CT	\$68	\$66	\$96	\$94	\$162	\$159
Delaware	DE	FLG-"Size"-DE	\$42	\$41	\$81	\$79	\$126	\$123	\$205	\$224	FLG-"Size"-DE	\$68	\$66	\$96	\$94	\$162	\$159
Florida	FL	FLG-"Size"-FL	\$42	\$41	\$81	\$79	\$126	\$123	\$205	\$224	FLG-"Size"-FL	\$68	\$66	\$96	\$94	\$162	\$159
Georgia	GA	FLG-"Size"-GA	\$42	\$41	\$72	\$70	\$99	\$97	\$205	\$224	FLG-"Size"-GA	\$61	\$60	\$92	\$90	\$127	\$125
Hawaii	HI	FLG-"Size"-HI	\$42	\$41	\$72	\$70	\$99	\$97	\$205	\$201	FLG-"Size"-HI	\$61	\$60	\$92	\$90	\$127	\$125
Idaho	ID	FLG-"Size"-ID	\$42	\$41	\$81	\$79	\$99	\$97	\$205	\$201	FLG-"Size"-ID	\$68	\$66	\$98	\$96	\$162	\$159
Illinois	IL	FLG-"Size"-IL	\$42	\$41	\$81	\$79	\$126	\$123	\$205	\$203	FLG-"Size"-IL	\$68	\$66	\$98	\$96	\$162	\$159
Indiana	IN	FLG-"Size"-IN	\$42	\$41	\$72	\$70	\$99	\$97	\$205	\$224	FLG-"Size"-IN	\$61	\$60	\$92	\$90	\$127	\$125
Iowa	IA	FLG-"Size"-IA	\$42	\$41	\$72	\$70	\$99	\$97	\$205	\$201	FLG-"Size"-IA	\$61	\$60	\$92	\$90	\$127	\$125
Kansas	KS	FLG-"Size"-KS	\$42	\$41	\$81	\$79	\$126	\$123	\$205	\$224	FLG-"Size"-KS	\$68	\$66	\$98	\$96	\$162	\$159
Kentucky	KY	FLG-"Size"-KY	\$42	\$41	\$81	\$79	\$126	\$123	\$205	\$224	FLG-"Size"-KY	\$68	\$66	\$98	\$96	\$162	\$159
Louisiana	LA	FLG-"Size"-LA	\$42	\$41	\$72	\$70	\$99	\$97	\$205	\$201	FLG-"Size"-LA	\$61	\$60	\$92	\$90	\$127	\$125
Maine	ME	FLG-"Size"-ME	\$42	\$41	\$81	\$79	\$126	\$123	\$205	\$201	FLG-"Size"-ME	\$68	\$66	\$98	\$96	\$162	\$159
Maryland	MD	FLG-"Size"-MD	\$42	\$41	\$72	\$70	\$99	\$97	\$205	\$201	FLG-"Size"-MD	\$61	\$60	\$92	\$90	\$127	\$125
Massachusetts	MA	FLG-"Size"-MA	\$42	\$41	\$72	\$70	\$99	\$97	\$205	\$201	FLG-"Size"-MA	\$61	\$60	\$92	\$90	\$127	\$125
Michigan	MI	FLG-"Size"-MI	\$42	\$41	\$81	\$79	\$126	\$123	\$205	\$224	FLG-"Size"-MI	\$68	\$66	\$98	\$96	\$162	\$159
Minnesota	MN	FLG-"Size"-MN	\$42	\$41	\$81	\$79	\$126	\$123	\$205	\$224	FLG-"Size"-MN	\$68	\$66	\$98	\$96	\$162	\$159
Mississippi	MS	FLG-"Size"-MS	\$42	\$41	\$72	\$70	\$99	\$97	\$205	\$224	FLG-"Size"-MS	\$61	\$60	\$92	\$90	\$127	\$125
Missouri	MO	FLG-"Size"-MO	\$42	\$41	\$81	\$79	\$126	\$123	\$205	\$224	FLG-"Size"-MO	\$68	\$66	\$98	\$96	\$162	\$159
Montana	MT	FLG-"Size"-MT	\$42	\$41	\$81	\$79	\$126	\$123	\$205	\$201	FLG-"Size"-MT	\$68	\$66	\$98	\$96	\$162	\$159
Nebraska	NE	FLG-"Size"-NE	\$42	\$41	\$72	\$70	\$99	\$97	\$205	\$201	FLG-"Size"-NE	\$61	\$60	\$92	\$90	\$127	\$125
Nevada	NV	FLG-"Size"-NV	\$42	\$41	\$72	\$70	\$99	\$97	\$205	\$201	FLG-"Size"-NV	\$61	\$60	\$92	\$90	\$127	\$125
New Hampshire	NH	FLG-"Size"-NH	\$42	\$41	\$81	\$79	\$126	\$123	\$205	\$224	FLG-"Size"-NH	\$68	\$66	\$98	\$96	\$162	\$159
New Jersey	NJ	FLG-"Size"-NJ	\$42	\$41	\$81	\$79	\$126	\$123	\$205	\$224	FLG-"Size"-NJ	\$68	\$66	\$98	\$96	\$162	\$159
New Mexico	NM	FLG-"Size"-NM	\$42	\$41	\$72	\$70	\$99	\$97	\$205	\$201	FLG-"Size"-NM	\$61	\$60	\$92	\$90	\$127	\$125
New York	NY	FLG-"Size"-NY	\$42	\$41	\$81	\$79	\$126	\$123	\$205	\$224	FLG-"Size"-NY	\$68	\$66	\$98	\$96	\$162	\$159
North Carolina	NC	FLG-"Size"-NC	\$42	\$41	\$72	\$70	\$99	\$97	\$205	\$201	FLG-"Size"-NC	\$61	\$60	\$92	\$90	\$127	\$125
North Dakota	ND	FLG-"Size"-ND	\$42	\$41	\$81	\$79	\$126	\$123	\$205	\$224	FLG-"Size"-ND	\$68	\$66	\$98	\$96	\$162	\$159
Ohio	OH	FLG-"Size"-OH	\$42	\$41	\$72	\$70	\$99	\$97	\$205	\$224	FLG-"Size"-OH	\$61	\$60	\$92	\$90	\$127	\$125
Oklahoma	OK	FLG-"Size"-OK	\$42	\$41	\$81	\$79	\$126	\$123	\$205	\$224	FLG-"Size"-OK	\$68	\$66	\$98	\$96	\$162	\$159
Oregon	OR	FLG-"Size"-OR	\$95	\$94	\$130	\$127	\$173	\$170	\$205	\$262	FLG-"Size"-OR	\$121	\$118	\$206	\$202	\$255	\$249
Pennsylvania	PA	FLG-"Size"-PA	\$42	\$41	\$81	\$79	\$126	\$123	\$205	\$201	FLG-"Size"-PA	\$68	\$66	\$98	\$96	\$162	\$159
Rhode Island	RI	FLG-"Size"-RI	\$42	\$41	\$72	\$70	\$99	\$97	\$205	\$201	FLG-"Size"-RI	\$61	\$60	\$92	\$90	\$127	\$125
South Carolina	SC	FLG-"Size"-SC	\$42	\$41	\$72	\$70	\$99	\$97	\$205	\$201	FLG-"Size"-SC	\$61	\$60	\$92	\$90	\$127	\$125
South Dakota	SD	FLG-"Size"-SD	\$42	\$41	\$72	\$70	\$99	\$97	\$205	\$201	FLG-"Size"-SD	\$61	\$60	\$92	\$90	\$127	\$125
Tennessee	TN	FLG-"Size"-TN	\$33	\$32	\$72	\$70	\$99	\$97	\$205	\$201	FLG-"Size"-TN	\$61	\$60	\$92	\$90	\$127	\$125
Texas	TX	FLG-"Size"-TX	\$33	\$32	\$42	\$41	\$63	\$62	\$205	\$112	FLG-"Size"-TX	\$48	\$47	\$65	\$63	\$91	\$89
Utah	UT	FLG-"Size"-UT	\$42	\$41	\$81	\$79	\$126	\$123	\$205	\$224	FLG-"Size"-UT	\$68	\$66	\$98	\$96	\$162	\$159
Vermont	VT	FLG-"Size"-VT	\$42	\$41	\$81	\$79	\$126	\$123	\$205	\$224	FLG-"Size"-VT	\$68	\$66	\$98	\$96	\$162	\$159
Virginia	VA	FLG-"Size"-VA	\$42	\$41	\$81	\$79	\$126	\$123	\$205	\$224	FLG-"Size"-VA	\$68	\$66	\$98	\$96	\$162	\$159
Washington	WA	FLG-"Size"-WA	\$71	\$70	\$98	\$96	\$147	\$144	\$205	\$234	FLG-"Size"-WA	\$121	\$118	\$206	\$202	\$255	\$249
West Virginia	WV	FLG-"Size"-WV	\$42	\$41	\$81	\$79	\$126	\$123	\$205	\$224	FLG-"Size"-WV	\$68	\$66	\$98	\$96	\$162	\$159
Wisconsin	WI	FLG-"Size"-WI	\$42	\$41	\$81	\$79	\$126	\$123	\$205	\$224	FLG-"Size"-WI	\$68	\$66	\$98	\$96	\$162	\$159
Wyoming	WY	FLG-"Size"-WY	\$42	\$41	\$72	\$70	\$99	\$97	\$205	\$201	FLG-"Size"-WY	\$61	\$60	\$92	\$90	\$127	\$125

*Nylon Flag Part Number Example:
FLG-0305N-AL (3' X 5' Nylon Alabama Flag)

**Polyester Flag Part Number Example:
FLG-0305P-AL (3' X 5' Polyester Alabama Flag)



Flagpole Balls



The Flagpole Ball is the most commonly used flagpole ornament. Sitting majestically above the flag and pole arrangement, it is considered the finishing touch for today's aluminum flagpole.

Concord American Flagpole offers Balls in a variety of finish and design options, allowing for a truly personal flagpole design. Balls are offered in Butt Diameters ranging from 3" to 24", with the recommended Ball diameter matching the butt diameter of the flagpole. Standard thread sizes are 1/2"-13NC, 5/8"-11NC, and 3/4"-10NC.

Concord American Flagpole's Patented Ball

is designed and manufactured to provide unmatched reliability. Natural pole vibration often causes premature flagpole ball failures, leading to high labor costs associated with replacement. Our patented design addresses the many issues seen in the standard ball construction offered by ALL others in the industry.

Heavy-Duty Aluminum Flagpole Ball

Industry Exclusive, Patented Ball Construction



Simply The Best
Flagpole Ball Available

Patent #7334535

For Component and Assembly Methods



- **A thick-wall, aluminum tube is incorporated as an inner spacer.**
Strengthens the assembly while assuring proper compression of the two ball spheres.
- **Thick spherical halves are spun with an extra wide lip at the joint.**
Significantly limits the upper half sphere's ability to slide down over the bottom half.
- **A stainless steel bolt and high strength adhesive compound secure the spacer rod at the ball tip.**
Eliminates the potential failures seen with rivet or internal mounted nuts.
- **A plated steel jamb nut is provided to secure the Ball to the truck assembly.**
Secure, permanent attachment to the flagpole truck.
- **4" to 8" Balls have ball stems machined from 3/4" diameter 6063 Aluminum and secured with a stainless steel threaded rod and high strength adhesive compound.**
Superior strength and protection against the rigors of pole vibration.
- **10" to 12" Balls are constructed with a 5/8" solid stainless steel threaded rod.**
Provides maximum strength for larger ball applications.
- **Heavy-Duty Aluminum Balls available in 4" to 24" Diameters.**
Gold Anodized, Clear Anodized, Powder Coated and Satin finishes.

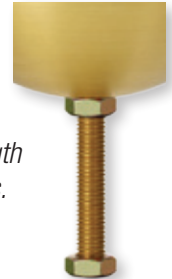

Gold Anodized Heavy-Duty Aluminum Ball

BALL SIZE	ROD SIZE	PART NUMBER	1+	6+	24+
			1/2" Rod		
4"	1/2"-13NC	BAL-0412-GLD	\$39	\$37	\$36
5"	1/2"-13NC	BAL-0512-GLD	\$43	\$41	\$40
6"	1/2"-13NC	BAL-0612-GLD	\$52	\$49	\$48
8"	1/2"-13NC	BAL-0812-GLD	\$83	\$79	\$77
			5/8" Rod		
4"	5/8"- 11NC	BAL-0458-GLD	\$39	\$37	\$36
5"	5/8"- 11NC	BAL-0558-GLD	\$43	\$41	\$40
6"	5/8"- 11NC	BAL-0658-GLD	\$52	\$49	\$48
8"	5/8"- 11NC	BAL-0858-GLD	\$83	\$79	\$77
10"	5/8"- 11NC	BAL-1058-GLD	\$121	\$114	\$112
12"	5/8"- 11NC	BAL-1258-GLD	\$146	\$138	\$136



Clear Anodized Heavy-Duty Aluminum Ball

BALL SIZE	ROD SIZE	PART NUMBER	1+	6+	24+
1/2" Rod					
4"	1/2"-13NC	BAL-0412-ACL	\$39	\$37	\$36
5"	1/2"-13NC	BAL-0512-ACL	\$43	\$41	\$40
6"	1/2"-13NC	BAL-0612-ACL	\$52	\$49	\$48
8"	1/2"-13NC	BAL-0812-ACL	\$83	\$79	\$77
5/8" Rod					
4"	5/8"- 11NC	BAL-0458-ACL	\$39	\$37	\$36
5"	5/8"- 11NC	BAL-0558-ACL	\$43	\$41	\$40
6"	5/8"- 11NC	BAL-0658-ACL	\$52	\$49	\$48
8"	5/8"- 11NC	BAL-0858-ACL	\$83	\$79	\$77
10"	5/8"- 11NC	BAL-1058-ACL	\$121	\$114	\$112
12"	5/8"- 11NC	BAL-1258-ACL	\$146	\$138	\$136



Powder Coated Heavy-Duty Aluminum Ball

BALL SIZE	ROD SIZE	PART NUMBER	1+	6+	24+
1/2" Rod					
4"	1/2"-13NC	BAL-0412-***	\$43	\$41	\$40
5"	1/2"-13NC	BAL-0512-***	\$48	\$46	\$45
6"	1/2"-13NC	BAL-0612-***	\$57	\$54	\$53
8"	1/2"-13NC	BAL-0812-***	\$91	\$86	\$84
5/8" Rod					
4"	5/8"- 11NC	BAL-0458-***	\$43	\$41	\$40
5"	5/8"- 11NC	BAL-0558-***	\$48	\$46	\$45
6"	5/8"- 11NC	BAL-0658-***	\$57	\$54	\$53
8"	5/8"- 11NC	BAL-0858-***	\$91	\$86	\$84
10"	5/8"- 11NC	BAL-1058-***	\$132	\$125	\$123
12"	5/8"- 11NC	BAL-1258-***	\$160	\$152	\$149



*** - Powder Coat Options
 BZT = BronzeTone
 BLK = Black
 WHT = White
 CLR = Clear

BronzeTone Shown

Satin Finish Heavy-Duty Aluminum Ball

BALL SIZE	ROD SIZE	PART NUMBER	1+	6+	24+
1/2" Rod					
4"	1/2"-13NC	BAL-0412-SAT	\$31	\$29	\$28
5"	1/2"-13NC	BAL-0512-SAT	\$34	\$33	\$32
6"	1/2"-13NC	BAL-0612-SAT	\$40	\$38	\$37
8"	1/2"-13NC	BAL-0812-SAT	\$63	\$61	\$60
5/8" Rod					
4"	5/8"- 11NC	BAL-0458-SAT	\$31	\$29	\$28
5"	5/8"- 11NC	BAL-0558-SAT	\$34	\$33	\$32
6"	5/8"- 11NC	BAL-0658-SAT	\$40	\$38	\$37
8"	5/8"- 11NC	BAL-0858-SAT	\$63	\$61	\$60
10"	5/8"- 11NC	BAL-1058-SAT	\$84	\$80	\$78
12"	5/8"- 11NC	BAL-1258-SAT	\$96	\$91	\$89



Extra-Large Heavy-Duty Aluminum Ball

BALL SIZE	ROD SIZE	PART NUMBER	1+	6+	24+
GoldTone					
18"	3/4"- 10NC	BAL-1834-GDT	\$816	\$774	\$759
24"	3/4"- 10NC	BAL-2434-GDT	\$924	\$878	\$860
Satin					
18"	3/4"- 10NC	BAL-1834-SAT	\$756	\$717	\$703
24"	3/4"- 10NC	BAL-2434-SAT	\$869	\$826	\$809



GOLDTONE SHOWN

Spun from 1/8" thick aluminum, these 18" and 24" diameter Balls are for use only with Heavy-Duty Truck assemblies and Stainless Steel Spindles.



Flagpole Balls and Finials

Traditional Construction Ball Ornaments are offered in Gold Anodized, Stainless Steel and 24K Gold Leaf. Texas Star and Christian Cross Finials are available in our GoldTone Powder Coat.



Gold Anodized Aluminum Ball Traditional Construction

BALL SIZE	ROD SIZE	PART NUMBER	1+	6+	24+
3"	1/2"-13NC	BAL-0312-GLD	\$23	\$22	\$21



Stainless Steel Ball Traditional Construction

BALL SIZE	ROD SIZE	PART NUMBER	1+	6+	24+
			1/2" Rod		
3"	1/2"-13NC	BAL-0312-ST	\$68	\$65	\$64
4"	1/2"-13NC	BAL-0412-ST	\$106	\$100	\$98
5"	1/2"-13NC	BAL-0512-ST	\$146	\$139	\$136
6"	1/2"-13NC	BAL-0612-ST	\$150	\$143	\$140
8"	1/2"-13NC	BAL-0812-ST	\$246	\$234	\$229
			5/8" Rod		
4"	5/8"- 11NC	BAL-0458-ST	\$106	\$100	\$98
5"	5/8"- 11NC	BAL-0558-ST	\$146	\$139	\$136
6"	5/8"- 11NC	BAL-0658-ST	\$150	\$143	\$140
8"	5/8"- 11NC	BAL-0858-ST	\$246	\$234	\$229
10"	5/8"- 11NC	BAL-1058-ST	\$384	\$364	\$357
12"	5/8"- 11NC	BAL-1258-ST	\$514	\$489	\$478



24k Gold Leaf Copper Ball Traditional Construction

BALL SIZE	ROD SIZE	PART NUMBER	1+	
			1/2" Rod	
4"	1/2"-13NC	BAL-0412-GLC	Pricing for Gold Leaf Copper Balls are subject to change due to the fluctuation in the market price of Gold. Please contact Concord American Flagpole Customer Service for price confirmation.	
5"	1/2"-13NC	BAL-0512-GLC		
6"	1/2"-13NC	BAL-0612-GLC		
8"	1/2"-13NC	BAL-0812-GLC		
				5/8" Rod
4"	5/8"- 11NC	BAL-0458-GLC		
5"	5/8"- 11NC	BAL-0558-GLC		
6"	5/8"- 11NC	BAL-0658-GLC		
8"	5/8"- 11NC	BAL-0858-GLC		
10"	5/8"- 11NC	BAL-1058-GLC		
12"	5/8"- 11NC	BAL-1258-GLC		

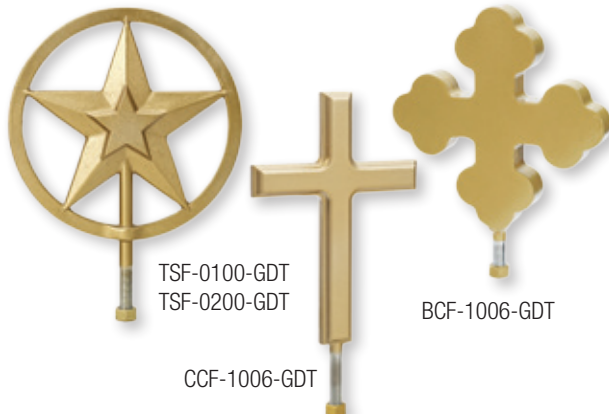

TSF-0100-GDT
TSF-0200-GDT

BCF-1006-GDT

CCF-1006-GDT

Finials

SIZE	ROD SIZE	PART NUMBER	1+	6+	24+
			Texas Star		
8" Dia.	1/2"-13NC	TSF-0100-GDT	\$82	\$78	\$76
12" Dia.	5/8"- 11NC	TSF-0200-GDT	\$164	\$152	\$149
			Christian Cross		
9"	1/2"-13NC	CCF-1006-GDT	\$82	\$78	\$76
			Botanee Cross		
8"	1/2"-13NC	BCF-1006-GDT	\$257	\$243	\$238

Texas Star, Christian and Botanee Cross Finials are the perfect complement for use atop flagpoles flying Texas or Christian flags. Each is constructed of heavy cast aluminum with steel attachment rod and finished in our GoldTone Powder Coat finish.



Use to modify trucks with existing 5/8"-11NC drillings to accept Balls/Ornaments with 1/2"-13NC threads.

Thread Adaptor

SIZE	ROD SIZE	PART NUMBER	1+	6+	24+
1/2" to 5/8"	1/2"- 13NC	THA-1258	\$68	\$63	\$62
5/8" to 1/2"	5/8"- 11NC	THA-5812	\$68	\$63	\$62



Eagles



EAG-0100-GDT (8")
EAG-0300-GDT (12")



EAG-0200-GDT (11")



EAG-0450-GDT (15")
EAG-0550-GDT (27")



EAG-0460-GDT (15")
EAG-0560-GDT (27")



EAG-0460-NAT (15")
EAG-0560-NAT (27")

EAG-0450-NAT (15")
EAG-0550-NAT (27")

Eagles - Cast Aluminum

DESCRIPTION	OVERALL WINGSPAN	WING-TIP TO WING-TIP	ROD SIZE	PART NUMBER	1+	6+	18+
GoldTone							
Flying Eagle/Ball	8"	6"	1/2"-13NC	EAG-0100-GDT	\$47	\$43	\$42
Flying Eagle/Ball	12"	9"	1/2"-13NC	EAG-0300-GDT	\$72	\$69	\$67
Landed Eagle/Ball	11"	7"	1/2"-13NC	EAG-0200-GDT	\$56	\$53	\$52
Flying Eagle	15"	9"	1/2"-13NC	EAG-0450-GDT	\$96	\$91	\$89
Flying Eagle	27"	15"	1/2"-13NC	EAG-0550-GDT	\$144	\$136	\$134
Flying Eagle On 3" Ball	15"	9"	1/2"-13NC	EAG-0460-GDT	\$101	\$95	\$94
Flying Eagle On 3" Ball	27"	15"	1/2"-13NC	EAG-0560-GDT	\$158	\$151	\$148
Natural Colors							
Flying Eagle	15"	9"	1/2"-13NC	EAG-0450-NAT	\$120	\$114	\$112
Flying Eagle	27"	15"	1/2"-13NC	EAG-0550-NAT	\$191	\$181	\$178
Flying Eagle On 3" Ball	15"	9"	1/2"-13NC	EAG-0460-NAT	\$139	\$132	\$130
Flying Eagle On 3" Ball	27"	15"	1/2"-13NC	EAG-0560-NAT	\$213	\$202	\$198

Cast Aluminum Eagles provide style and size options for all flagpole heights. Standard options include **Eagle Only** and **Eagle On Ball** in both **GoldTone** and **Natural Color** finish options. Overall Wingspan is measured from wing-tip, across back, to opposite wing-tip and is approximate.

Note: Wingspan in inches should approximate 1/2 of flagpole height in feet.

Extra-Large Flying Eagle - Cast Aluminum

The **Extra-Large Cast Aluminum Eagle** is designed for larger Internal and External flagpoles up to 100'. It requires the use of a Heavy-Duty, External Halyard Truck Assembly (See Page 61), a Heavy-Duty Truck Assembly with an 8", 10" or 12" Heavy-Duty Aluminum Ball, or the 12" External or Internal Ball Truck Assembly (See Pages 63 and 66). A Stainless Steel Spindle (See Page 67) in the Truck or Ball Truck is also required. Contact Customer Service for pricing and for information on color options and special applications.



- Overall Wingspan – 44"
- Wing-Tip to Wing-Tip – 33"
- Rod Size – 3/4"-10NC
- GoldTone Powder Coat Finish



External Trucks

External Flagpole Trucks sit at the top of each flagpole, providing an exposed pulley and rope system for raising and lowering the flag.

All Trucks are designed to accept Balls, Eagles and Finials. Standard Spindle Threading is 1-1/4" NPT (1" NPT and 1-1/2" NPT Spindles available upon request). External Halyard Trucks may be combined to achieve quantity discounts.

Cap Design Trucks install over the top of the flagpole and are attached with anchoring set screws or bolts. **Spindle Design Trucks** incorporate a threaded spindle which is installed into a female fitting welded into the top of the flagpole. **Stationary Trucks** are fixed and will not rotate. **Revolving Trucks** rotate the flag with the wind.

*** - Specify Powder Coat Option
 BZT = BronzeTone WHT = White
 BLK = Black CLR = Clear



External Stationary - Cap Design



External Single Revolving - Spindle Design



External Double Revolving - Spindle Design



External Halyard - Cap Style Single Stationary Truck

PART NUMBER	SHAFT TOP DIAMETER	PULLEY	1+	6+	18+
Satin Finish					
TRK-9100	1-7/8" - 2"	Nylon	\$27	\$26	\$25
TRK-9101	1-7/8" - 2"	Aluminum	\$38	\$37	\$36
TRK-9200	2-3/8" - 2-1/2"	Nylon	\$35	\$33	\$31
TRK-9201	2-3/8" - 2-1/2"	Aluminum	\$46	\$45	\$42
TRK-9300	2-7/8" - 3"	Nylon	\$36	\$34	\$33
TRK-9301	2-7/8" - 3"	Aluminum	\$47	\$46	\$43
TRK-9320	3-1/2"	Aluminum	\$57	\$55	\$53
TRK-9210	4"	Aluminum	\$113	\$109	\$105
TRK-9220	4-1/2"	Aluminum	\$113	\$109	\$105
TRK-9230	5"	Aluminum	\$138	\$132	\$127
TRK-9240	5-1/2"	Aluminum	\$138	\$132	\$127
Powder Coat					
TRK-9100-***	1-7/8" - 2"	Nylon	\$33	\$31	\$30
TRK-9101-***	1-7/8" - 2"	Aluminum	\$43	\$42	\$40
TRK-9200-***	2-3/8" - 2-1/2"	Nylon	\$40	\$38	\$37
TRK-9201-***	2-3/8" - 2-1/2"	Aluminum	\$51	\$50	\$48
TRK-9300-***	2-7/8" - 3"	Nylon	\$41	\$39	\$37
TRK-9301-***	2-7/8" - 3"	Aluminum	\$52	\$51	\$48
TRK-9320-***	3-1/2"	Aluminum	\$64	\$61	\$59
TRK-9210-***	4"	Aluminum	\$120	\$115	\$110
TRK-9220-***	4-1/2"	Aluminum	\$120	\$115	\$110
TRK-9230-***	5"	Aluminum	\$147	\$141	\$136
TRK-9240-***	5-1/2"	Aluminum	\$147	\$141	\$136



- Cast Aluminum Body.
- Aluminum Pulley on Stainless Steel Axle. Nylon Pulley on Stainless Steel Axle available in sizes to 3".
- 1/2"-13NC Top Drilling.
- Recommended Halyard Diameter – 5/16".
- Stainless Steel Set Screws (3) on sizes to 3-1/2" or Stainless Steel Bolts (3) on sizes 4" and larger are provided.
- See Page 62 – External Halyard Cap Style Single Revolving Truck for options to convert Stationary flagpoles into Revolving systems.



TRK-9610



External Halyard - In-Line Single Revolving Truck

PART NUMBER	MAX. SHAFT TOP DIAMETER	1+	6+	18+
Satin Finish				
TRK-9610	4"	\$76	\$72	\$70
Powder Coat				
TRK-9610-***	4"	\$88	\$85	\$82

- In-Line Cast Aluminum Body.
- Single Aluminum Pulley on Stainless Steel Axle.
- Upper and Lower Stainless Steel Ball Bearing Assemblies.
- 1-1/4" NPT Spindle.
- 1/2"-13NC Top Drilling.
- Recommended Halyard Diameter – 5/16".



External Halyard - Single Revolving Truck

PART NUMBER	MAX. SHAFT TOP DIAMETER	1+	6+	18+
Satin Finish				
TRK-9609	4"	\$88	\$78	\$76
Powder Coat				
TRK-9609-***	4"	\$101	\$89	\$87

- Cast Aluminum Body.
- Single Aluminum Pulley on Stainless Steel Axle.
- Upper and Lower Stainless Steel Ball Bearing Assemblies.
- Non-Fouling Design.
- 1-1/4" NPT Spindle.
- 1/2"-13NC Top Drilling.
- Recommended Halyard Diameter – 5/16".



External Halyard - Double Revolving Truck

PART NUMBER	MAX. SHAFT TOP DIAMETER	1+	6+	18+
Satin Finish				
TRK-9709	4"	\$111	\$96	\$95
Powder Coat				
TRK-9709-***	4"	\$127	\$111	\$109

- Cast Aluminum Body.
- Double Aluminum Pulleys on Stainless Steel Axles.
- Upper and Lower Stainless Steel Ball Bearing Assemblies.
- Non-Fouling Design.
- 1-1/4" NPT Spindle.
- 1/2"-13NC Top Drilling.
- Recommended Halyard Diameter – 5/16".

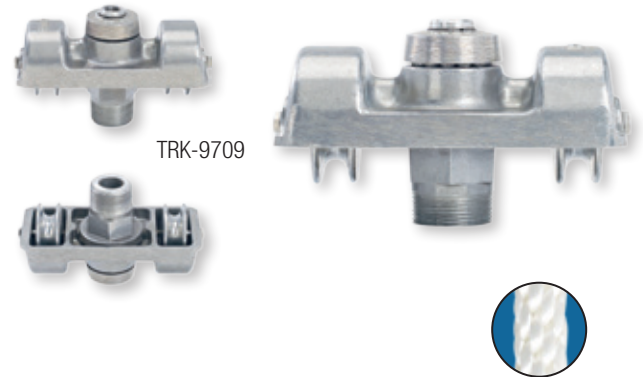

External Halyard - Heavy-Duty Single Revolving Truck

PART NUMBER	MAX. SHAFT TOP DIAMETER	1+	6+	18+
Satin Finish				
TRK-9420	4-1/2"	\$201	\$194	\$187
TRK-9430	7-1/2"	\$297	\$285	\$273
Powder Coat				
TRK-9420-***	4-1/2"	\$216	\$208	\$199
TRK-9430-***	7-1/2"	\$318	\$305	\$292

- Heavyweight Cast Aluminum Body and Components.
- Single Aluminum Pulley with Stainless Steel Axle.
- SEALED Upper and Lower Stainless Steel Ball Bearing Assemblies.
- 1-1/4" NPT Spindle.
- 1/2"-13NC Top Drilling.
- Recommended Halyard Diameter – 3/8".

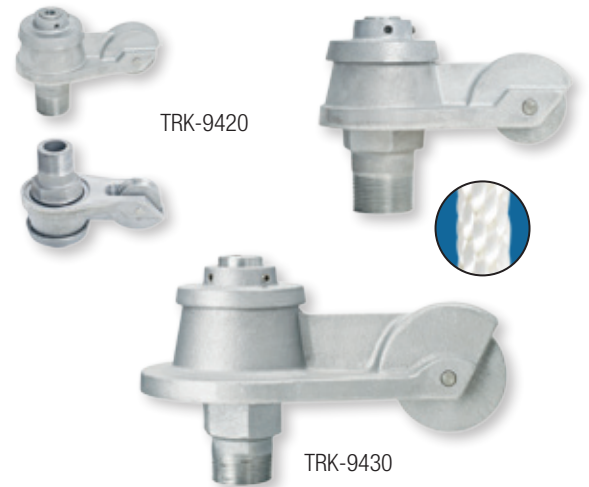

External Halyard - Heavy-Duty Double Revolving Truck

PART NUMBER	MAX. SHAFT TOP DIAMETER	1+	6+	18+
Satin Finish				
TRK-9975	5-1/2"	\$227	\$218	\$209
TRK-9750	9"	\$476	\$456	\$438
Powder Coat				
TRK-9975-***	5-1/2"	\$250	\$240	\$231
TRK-9750-***	9"	\$513	\$494	\$472

- Heavyweight Cast Aluminum Body and Components.
- Double Aluminum Pulleys with Stainless Steel Axle.
- SEALED Upper and Lower Stainless Steel Ball Bearing Assemblies.
- 1-1/4" NPT Spindle.
- 1/2"-13NC Top Drilling.
- Recommended Halyard Diameter – 3/8".

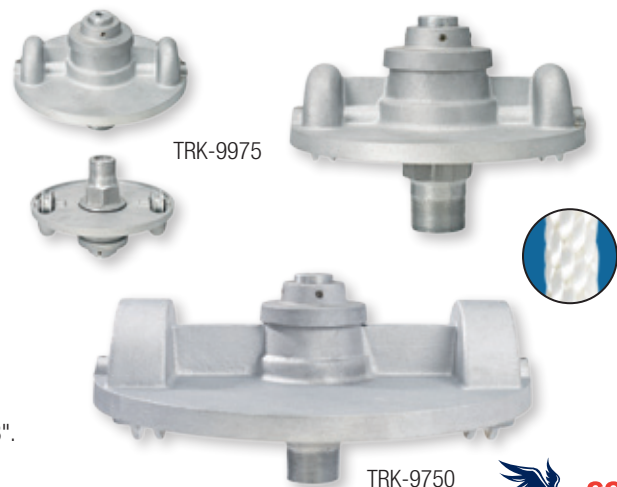

Use to modify original **External Stationary** systems (or *Revolving systems with damaged top insert threads*) into a **Revolving** system. Contact Customer Service for applications requiring larger custom sizes.



NYLON PULLEY AVAILABLE

- Cast Aluminum Truck Body and Adapter.
- Single Nylon or Aluminum Pulley on Stainless Steel Axle.
- Attach with three (3) Stainless Steel Set Screws.
- Upper and Lower Stainless Steel Ball Bearing Assemblies.

External Halyard Cap Style Single Revolving Truck

PART NUMBER	SHAFT TOP DIAMETER	PULLEY	1+	6+	18+
Satin Finish					
TRK-9350	1-7/8" - 2"	Nylon	\$85	\$82	\$78
TRK-9351	1-7/8" - 2"	Aluminum	\$95	\$92	\$89
TRK-9365	2-3/8" - 2-1/2"	Nylon	\$91	\$88	\$84
TRK-9366	2-3/8" - 2-1/2"	Aluminum	\$102	\$98	\$95
TRK-9370	2-7/8" - 3"	Nylon	\$94	\$91	\$87
TRK-9371	2-7/8" - 3"	Aluminum	\$106	\$101	\$98
Powder Coat					
TRK-9350-***	1-7/8" - 2"	Nylon	\$112	\$108	\$104
TRK-9351-***	1-7/8" - 2"	Aluminum	\$123	\$118	\$114
TRK-9365-***	2-3/8" - 2-1/2"	Nylon	\$118	\$114	\$109
TRK-9366-***	2-3/8" - 2-1/2"	Aluminum	\$129	\$125	\$120
TRK-9370-***	2-7/8" - 3"	Nylon	\$120	\$115	\$110
TRK-9371-***	2-7/8" - 3"	Aluminum	\$130	\$126	\$121

- 1/2"-13NC Top Drilling.
- Recommended Halyard Diameter – 5/16".



- Cast Aluminum construction.
- Tapped 1-1/4" NPT.
- Up to 2-1/2" Shaft Top Diameter provided with three (3) Stainless Steel Set Screws.
- 3" to 4" sizes provided with three (3) Self-Tapping Stainless Steel Screws.
- 4-1/2" and larger sizes provided with three (3) Stainless Steel Bolts.



Custom larger sizes available. Contact Customer Service for size and pricing options.

Create **External Revolving Systems** from existing Stationary systems (or *Revolving systems with damaged top insert threads*). Revolving Trucks sold separately.

*** - Specify Powder Coat Option
 BZT = Bronze Tone
 BLK = Black
 WHT = White
 CLR = Clear

Cap Style Truck Adapters

PART NUMBER	SHAFT TOP DIAMETER	1+	6+	18+
Satin Finish				
TRK-2000	2"	\$55	\$52	\$50
TRK-2020	2-3/8"	\$55	\$52	\$50
TRK-2010	2-1/2"	\$55	\$52	\$50
TRK-2030	3"	\$60	\$58	\$55
TRK-2045	3-1/2"	\$60	\$58	\$55
TRK-2050	4"	\$71	\$68	\$66
TRK-2055	4-1/2"	\$71	\$68	\$66
TRK-2061	5"	\$95	\$91	\$88
TRK-2070	5-1/2"	\$95	\$91	\$88
Powder Coat				
TRK-2000-***	2"	\$65	\$62	\$60
TRK-2020-***	2-3/8"	\$65	\$62	\$60
TRK-2010-***	2-1/2"	\$65	\$62	\$60
TRK-2030-***	3"	\$71	\$68	\$66
TRK-2045-***	3-1/2"	\$71	\$68	\$66
TRK-2050-***	4"	\$84	\$81	\$78
TRK-2055-***	4-1/2"	\$84	\$81	\$78
TRK-2061-***	5"	\$109	\$105	\$100
TRK-2070-***	5-1/2"	\$109	\$105	\$100

External Halyard Mega-Trucks & Mega Ball Trucks

Concord American Flagpole offers a wide selection of large external halyard trucks... **MEGA-TRUCKS**... which are designed to be used on poles with top diameters up to 36". All components are significantly strengthened to address the demands placed on them. Stainless Steel Spindles and SEALED bearings are standard. EXTRA-LARGE, heavy gauge aluminum Balls in diameters of 18" and 24" with Stainless Steel Spindles (See Page 57) and 44" Cast Aluminum Flying Eagles (See Page 59) are manufactured for use with MEGA-TRUCKS. MEGA-TRUCKS are the perfect solution for use with cell towers, large light poles and other special applications. Contact Customer Service with your specific requirements.

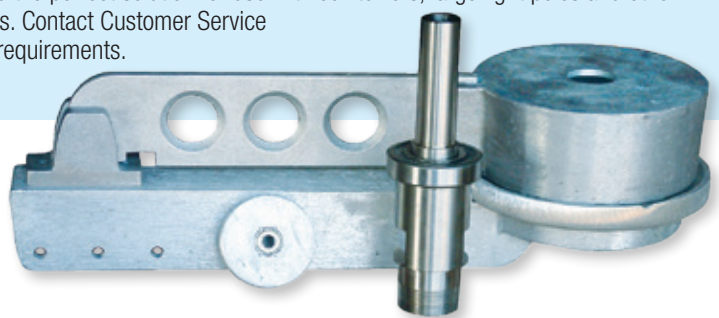

External Ball Truck

Concord American Flagpole's Ball Truck designs combine the function of the truck assembly with the ornamental features of a ball finial. With superior aesthetics and unmatched durability, these heavy-duty designs offer Architects, Specifiers and Project Owners a unique and durable truck assembly option.



***** - Specify Powder Coat Option**

- BZT = BronzeTone
- BLK = Black
- WHT = White
- CLR = Clear

External Halyard – 8" Cast Ball Truck Heavy-Duty Single Revolving

PART NUMBER	DESCRIPTION	1+	3+	7+
GoldTone				
TRK-9446-GDT	8" Diameter Cast Ball Truck	\$316	\$302	\$296
Powder Coat				
TRK-9446-***	8" Diameter Cast Ball Truck	\$316	\$302	\$296
Satin				
TRK-9446	8" Diameter Cast Ball Truck	\$277	\$266	\$261

- Cast Aluminum construction with GoldTone Powder Coated finish.
- Aluminum Pulley on Stainless Steel Axle.
- SEALED Upper and Lower Stainless Steel Ball Bearing Assemblies.
- 1-1/4" NPT Spindle. Stainless Steel Spindle option available (Add "SS" to Part Number – Example TRK-9446SS-GDT - Add \$240).
- Factory-Attached Eagles are available. Contact Customer Service for size and pricing options.



External Halyard – 10" & 12" Cast Ball Truck Heavy-Duty Single Revolving

PART NUMBER	DESCRIPTION	1+	3+	7+
GoldTone				
TRK-9416-GDT	10" Diameter Cast Ball Truck	\$505	\$483	\$474
TRK-9456-GDT	12" Diameter Cast Ball Truck	\$761	\$734	\$719
Powder Coat				
TRK-9416-***	10" Diameter Cast Ball Truck	\$505	\$483	\$474
TRK-9456-***	12" Diameter Cast Ball Truck	\$761	\$734	\$719
Satin				
TRK-9416	10" Diameter Cast Ball Truck	\$464	\$446	\$437
TRK-9456	12" Diameter Cast Ball Truck	\$701	\$674	\$660

- Cast Aluminum construction with GoldTone Powder Coated finish.
- Aluminum Pulley on Stainless Steel Axle.
- SEALED Upper and Lower Stainless Steel Ball Bearing Assemblies.
- 1-1/4" NPT Spindle. Stainless Steel Spindle option available (Add "SS" to Part Number – Example TRK-9416SS-GDT - Add \$240).
- Factory-Attached Eagles are available. Contact Customer Service for size and pricing options.



External Halyard – Cast Ball Truck Cap Style Stationary

PART NUMBER	DESCRIPTION	1+	3+	7+
GoldTone				
TRK-9126-GDT	Flagpole Top Dia. 2" - Ball Dia. 4-1/2"	\$77	\$70	\$69
TRK-9136-GDT	Flagpole Top Dia. 3" - Ball Dia. 6-1/2"	\$104	\$98	\$96
Satin Finish				
TRK-9126	Flagpole Top Dia. 2" - Ball Dia. 4-1/2"	\$60	\$57	\$56
TRK-9136	Flagpole Top Dia. 3" - Ball Dia. 6-1/2"	\$87	\$85	\$83

- Cast Aluminum construction with GoldTone Powder Coated finish.
- Nylon Pulley on Stainless Steel Axle.
- Attaches with a Stainless Steel Set Screw (provided).





Internal Trucks

Internal Flagpole Trucks sit at the top of the flagpole, providing a system that encloses either Rope Halyard (*Cam Cleat Systems*) or Wire Halyard (*Winch Systems*) behind the security of a lockable access door. Internal Trucks are offered in **Stationary** and **Revolving** options (See Pages 8-9) in

either **Cap Style** or **Threaded Spindle** designs. All Trucks are designed to accept Balls, Eagles and Finials. Internal Halyard Trucks may be combined to achieve quantity discounts.

*** - Specify Powder Coat Option
 BZT = Bronze Tone WHT = White
 BLK = Black CLR = Clear



Internal Single Stationary - Cap Design

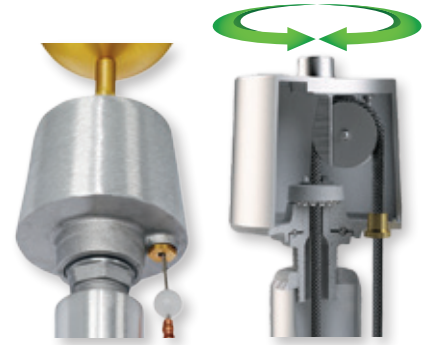

Internal Revolving - Spindle Design



NYLON PULLEY AVAILABLE



Internal Halyard Stationary Truck Rope Halyard

PART NUMBER	SHAFT TOP DIAMETER	PULLEY	1+	3+	7+
Satin Finish					
TRK-9901	3"	Nylon	\$55	\$52	\$50
TRK-9902	3"	Aluminum	\$65	\$62	\$60
TRK-9912	3-1/2"	Aluminum	\$92	\$88	\$85
Powder Coat					
TRK-9901-***	3"	Nylon	\$62	\$59	\$56
TRK-9902-***	3"	Aluminum	\$72	\$69	\$67
TRK-9912-***	3-1/2"	Aluminum	\$99	\$95	\$91

- Cast Aluminum Body.
- External Aluminum or Nylon Pulley on Stainless Steel Axle. Internal Nylon Pulley.
- Attached with three (3) Stainless Steel Set Screws.
- 1/2"-13NC Top Drilling.
- Recommended Halyard Diameter – 5/16".
- Contact Customer Service for applications requiring larger custom sizes.

Internal Halyard Revolving Truck Rope Halyard



PART NUMBER	DESCRIPTION	MAX. SHAFT TOP DIA.	1+	3+	7+
Satin Finish					
TRK-9680	SMALL - Stainless Steel Bearings On A Cast Bearing Race	3-1/2"	\$191	\$182	\$175
TRK-9660	SMALL - Dual SEALED Bearing Assemblies	3-1/2"	\$268	\$255	\$244
Powder Coat					
TRK-9680-***	SMALL - Stainless Steel Bearings On A Cast Bearing Race	3-1/2"	\$225	\$214	\$206
TRK-9660-***	SMALL - Dual SEALED Bearing Assemblies	3-1/2"	\$302	\$287	\$275

- Constructed from heavy Cast Aluminum in a two-piece, removable hood design.
- Internal, Cast Aluminum Pulley.
- Cast Brass Halyard Exit Bushing reduces wear, significantly increasing Truck life.
- Options include Dual Stainless Steel Ball Bearing on a Cast Bearing Race or Dual SEALED Bearing Assemblies.
- 1-1/4" NPT Spindle. Stainless Steel Spindle option available only on TRK-9660. (Add "SS" to Part Number – Example TRK-9660SS - Add \$240).
- 1/2"-13NC Top Drilling.

Internal Halyard - Standard Cone Style Revolving Truck Wire Halyard

PART NUMBER	DESCRIPTION	MAX. SHAFT	1+	3+	7+
		TOP DIA.			
Satin Finish					
TRK-9670	STD. - Stainless Steel Bearings On A Cast Bearing Race	3-1/2"	\$191	\$182	\$175
TRK-9650	STANDARD - Dual SEALED Bearing Assemblies	3-1/2"	\$268	\$255	\$244
Powder Coat					
TRK-9670-***	STD. - Stainless Steel Bearings On A Cast Bearing Race	3-1/2"	\$225	\$214	\$206
TRK-9650-***	STANDARD - Dual SEALED Bearing Assemblies	3-1/2"	\$302	\$276	\$265

- Constructed from heavy Cast Aluminum in a two-piece, removable hood design.
- Internal, Cast Aluminum Pulley.
- Cast Brass Halyard Exit Bushing reduces wear, significantly increasing Truck life.
- Options include Dual Stainless Steel Ball Bearing on a Cast Bearing Race or Dual SEALED Bearing Assemblies.
- 1/2"-13NC Top Drilling.
- 1-1/4" NPT Spindle. Stainless Steel Spindle option available only on TRK-9650. (Add "SS" to Part Number – Example TRK-9650SS - Add \$240).

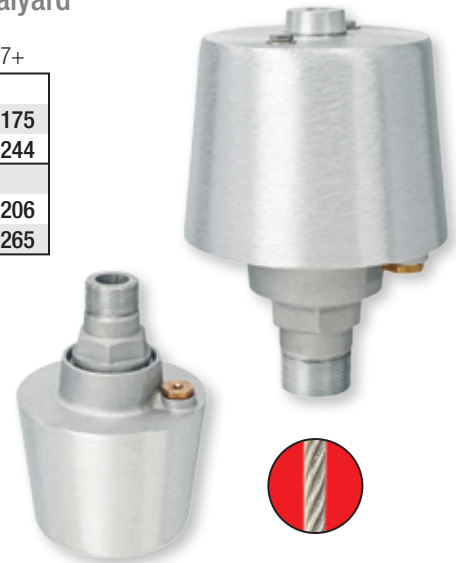

Internal Halyard - Large Cone Style Revolving Truck Wire Halyard

PART NUMBER	DESCRIPTION	MAX. SHAFT	1+	3+	7+
		TOP DIA.			
Satin Finish					
TRK-9800	LARGE - Dual SEALED Bearing Assemblies	4-1/2"	\$408	\$387	\$372
Powder Coat					
TRK-9800-***	LARGE - Dual SEALED Bearing Assemblies	4-1/2"	\$435	\$413	\$396

- Constructed from heavy Cast Aluminum in a two-piece, removable hood design.
- Internal, Cast Aluminum Pulley.
- Cast Brass Halyard Exit Bushing reduces wear, significantly increasing Truck life.
- 1/2"-13NC Top Drilling.
- 1-1/4" NPT Spindle. Stainless Steel Spindle option available (Add "SS" to Part Number – Example TRK-9800SS - Add \$240).

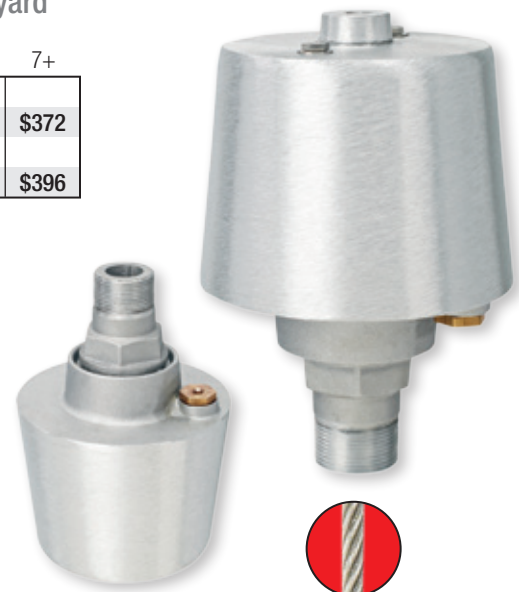

Internal Halyard - Extra-Large Cone Style Revolving Truck Wire Halyard

PART NUMBER	DESCRIPTION	MAX. SHAFT	1+	3+	7+
		TOP DIA.			
Satin Finish					
TRK-9900	EXTRA-LARGE - Dual SEALED Bearing Assemblies	7-1/2"	\$642	\$609	\$584
Powder Coat					
TRK-9900-***	EXTRA-LARGE - Dual SEALED Bearing Assemblies	7-1/2"	\$690	\$652	\$626

- Constructed from heavy Cast Aluminum in a two-piece, removable hood design.
- Internal, Cast Aluminum Pulley.
- Cast Brass Halyard Exit Bushing reduces wear, significantly increasing Truck life.
- 1/2"-13NC Top Drilling.
- 1-1/4" NPT Spindle. Stainless Steel Spindle option available (Add "SS" to Part Number – Example TRK-9900SS - Add \$240).



Internal Ball Truck

Concord American Flagpole's Ball Truck combines the function of the truck assembly with the ornamental features of a ball finial, offering Architects, Specifiers and Project Owners a unique truck assembly with superior aesthetics and unmatched durability.

- Cast Aluminum construction with GoldTone Powder Coated finish.
- Internal, Aluminum Pulley.
- SEALED Upper and Lower Stainless Steel Ball Bearing Assemblies.
- Cast Brass Halyard Exit Bushing reduces wear, significantly increasing Truck life.

- 1-1/4" NPT Spindle. Stainless Steel Spindle option available (Add "SS" to Part Number – Example TRK-9646SS-GDT - Add \$240).
- Factory-Attached Eagles are available. Extra-Large Flying Eagle available only on TRK-9856 and TRK-9876. Contact Customer Service for size and pricing options.

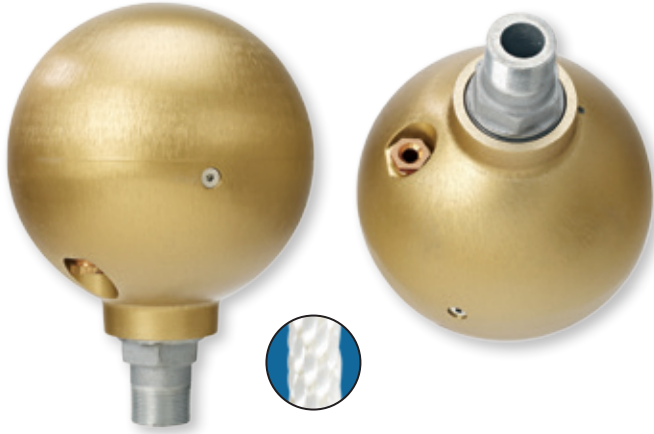

Internal Halyard – 8" Cast Ball Truck For Use With Rope Halyard Cam Cleat Flagpole Systems

PART NUMBER	CAST BALL SIZE	MAX. TOP DIA.	1+	3+	7+
GoldTone					
TRK-9646-GDT	8"	3-1/2"	\$321	\$307	\$301
Powder Coat					
TRK-9646-***	8"	3-1/2"	\$321	\$307	\$301
Satin Finish					
TRK-9646	8"	3-1/2"	\$288	\$277	\$271

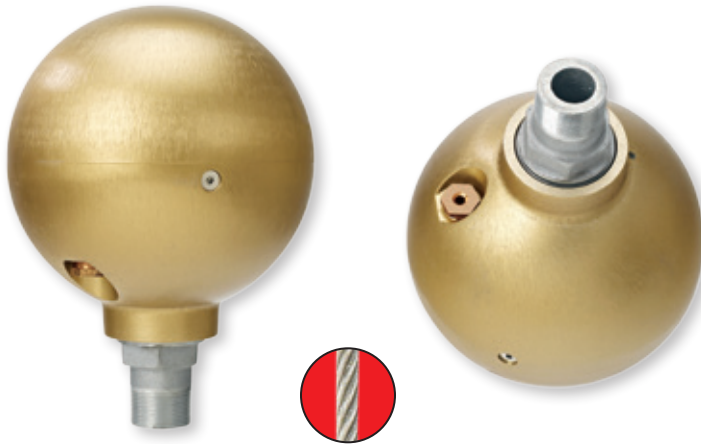

Internal Halyard – 8" Cast Ball Truck For Use With Wire Halyard Winch Flagpole Systems

PART NUMBER	CAST BALL SIZE	MAX. TOP DIA.	1+	3+	7+
GoldTone					
TRK-9846-GDT	8"	3-1/2"	\$321	\$307	\$301
Powder Coat					
TRK-9846-***	8"	3-1/2"	\$321	\$307	\$301
Satin Finish					
TRK-9846	8"	3-1/2"	\$288	\$277	\$271



Internal Halyard – 10" to 18" Cast Ball Truck For Use With Wire Halyard Winch Flagpole Systems

PART NUMBER	CAST BALL SIZE	MAX. TOP DIA.	1+	3+	7+
GoldTone					
TRK-9816-GDT	10"	4"	\$496	\$476	\$467
TRK-9856-GDT	12"	4-1/2"	\$616	\$587	\$575
TRK-9876-GDT	18"	7-1/2"	\$1,342	\$1,288	\$1,262
BronzeTone					
TRK-9816-***	10"	4"	\$496	\$476	\$467
TRK-9856-***	12"	4-1/2"	\$616	\$587	\$575
TRK-9876-***	18"	7-1/2"	\$1,342	\$1,288	\$1,262
Satin Finish					
TRK-9816	10"	4"	\$464	\$446	\$437
TRK-9856	12"	4-1/2"	\$570	\$543	\$533
TRK-9876	18"	7-1/2"	\$1,342	\$1,275	\$1,249

Stainless Steel Truck Spindles

For Revolving Truck Assemblies

Stainless Steel Spindles are strongly recommended for special applications that put considerable stress on the truck and spindle assemblies. Examples include large Eagles, tall flagpoles, roof mount applications, flagpoles flying extremely large or multiple flags and high wind areas. Several spindle lengths and NPT thread size combinations are available. **Contact Customer Service for availability and specification assistance.**



DESCRIPTION	FOR USE WITH	1+
Stainless Steel Spindles	Internal and External Halyard Truck Assemblies	\$240

Side Mount Trucks for Light Poles

Turns Existing Poles Into A Flag or Banner Pole

- Easily allows the raising, lowering and changing of flags, banners or pennants without hoists or ladders.
- Professional results without the need to drill the pole.
- Flags or messaging can be quickly changed or removed in inclement weather.
- Attach using two (2) Stainless Steel Hose Clamps (*by others*). Design does accommodate bolting if desired.
- Cleat Adapter is available for Cleat installation without pole drilling. Adapter attaches with two (2) Stainless Steel Hose Clamps (*by others*).

Side Mount Kit consists of the following parts.

- TRK-9160 Side Mount Truck.
- CLA-9060 6" Cleat with two (2) Stainless Steel Screws.
- CLA-9900 Cleat Adapter.
- CLA-0200 Nickel Plated Flagsnaps – Qty. (2).
- SNP-0500-WHT White Flagsnap Covers – Qty. (2).
- HAL-0710 Polyester Rope Halyard – Qty. 55'.

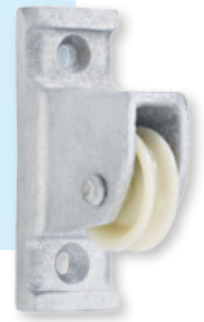

TRK-9160



TRK-9060



CLA-9900



CLA-0200



SNP-0500-WHT



HAL-0710

PART NUMBER	DESCRIPTION	1+	6+	18+
Satin Finish				
TRK-1000	Complete Side Mount Kit	\$73	\$71	\$68
TRK-9160	Side Mount Truck ONLY	\$22	\$21	\$20
CLA-9900	Cleat Adapter	\$7	\$6	\$5
Powder Paint				
TRK-1000-***	Complete Side Mount Kit	\$84	\$81	\$79
TRK-9160-***	Side Mount Truck ONLY	\$29	\$28	\$27
CLA-9900-***	Cleat Adapter	\$12	\$11	\$10

Red Beacon Light Assembly External Halyard Systems

FAA approved Red Beacon Light Assemblies for External Halyard Systems are available in Light Bulb and LED styles in both Single and Double Lens options. Bulb(s) sold separately for the traditional Light Bulb style. ***LED style options include bulb(s) and have a 5-Year Warranty. LED bulbs cannot be replaced.**

All options incorporate 3/4" NPT internal threads and require the use of both the Heavy-Duty Truck Assembly TRK-9420 (*or TRK-9975*) and Stainless Steel Spindle TRK-5120 (*both sold separately*). Heavy-Duty Truck and Stainless Steel Spindle will be modified and assembled at the factory.

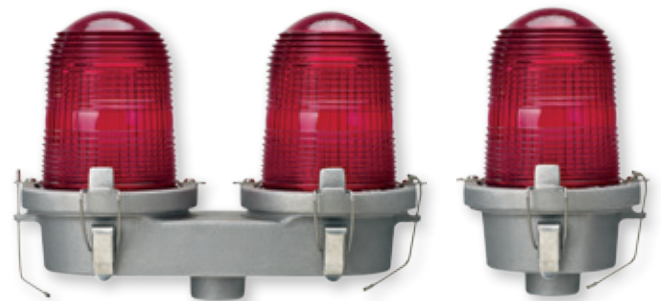

TRK-5170 or TRK-5180

TRK-5150 or TRK-5160

PART NUMBER	DESCRIPTION	1+	6+
TRK-5150	LIGHT BULB STYLE - Single Lens	\$230	\$217
TRK-5170	LIGHT BULB STYLE - Double Lens	\$435	\$414
TRK-5160	LED - Single Lens*	\$542	\$518
TRK-5180	LED - Double Lens*	\$1,033	\$981
TRK-5155	Replacement Bulb (LIGHT BULB STYLE)	\$25	\$23



TRK-9420



TRK-5120

TRK-5155

External Heavy-Duty Truck And Stainless Steel Spindle Required

PART NUMBER	DESCRIPTION	1+	6+	18+
Satin Finish				
TRK-9420	Heavy-Duty Single Revolving Truck	\$201	\$194	\$187
TRK-9975	Heavy-Duty Double Revolving Truck	\$227	\$218	\$209
TRK-5120	SS Spindle - 1-1/4" NPT Base to 3/4" NPT Top	\$238	-	-



TRK-9975



Rope Halyard

Concord American Flagpole offers a complete line of Rope Halyards that are specially designed for the rigorous demands of outdoor flagpole systems. Available in various size and material specifications, all are braided, multifilament styles containing a smooth and rounded form perfect for flagpole pulley applications. For use in both External and Internal Cam Cleat applications.



Spools
Spools of Polyester, Nylon and Wire Core Rope Halyard are available.

Polyester Halyard

Strong, lightweight and rot and mildew resistant, Polyester Halyard combines good flexibility and shock load absorption with excellent resistance to abrasion.



WHITE POLYESTER ROPE



BRONZE TONE POLYESTER ROPE



BLACK POLYESTER ROPE



SILVER POLYESTER ROPE

Polyester Halyard

PART NUMBER	DESCRIPTION	TYPICAL SPOOL LENGTH	CUT TO LENGTH - PRICE/LINEAL FOOT		
			< 500'	500'+	1,000'+
White					
HAL-0705-WHT	1/4" - Polyester #8	1,000'	\$0.30	\$0.28	\$0.24
HAL-0710-WHT	5/16" - Polyester #10	1,000'	\$0.42	\$0.38	\$0.36
HAL-0715-WHT	3/8" - Polyester #12	500'	\$0.60	\$0.54	\$0.52
BronzeTone					
HAL-0705-BZT	1/4" - Polyester #8	500'	\$0.32	\$0.30	\$0.26
HAL-0710-BZT	5/16" - Polyester #10	1,000'	\$0.44	\$0.40	\$0.38
HAL-0715-BZT	3/8" - Polyester #12	500'	\$0.54	\$0.50	\$0.46
Black					
HAL-0705-BLK	1/4" - Polyester #8	1,000'	\$0.32	\$0.30	\$0.26
HAL-0710-BLK	5/16" - Polyester #10	1,000'	\$0.44	\$0.40	\$0.38
HAL-0715-BLK	3/8" - Polyester #12	500'	\$0.54	\$0.50	\$0.46
Silver					
HAL-0710-SIL	5/16" - Polyester #10	1,000'	\$0.44	\$0.38	\$0.36



Polyester Wire Core Halyard

PART NUMBER	DESCRIPTION	TYPICAL SPOOL LENGTH	CUT TO LENGTH - PRICE/LINEAL FOOT		
			< 500'	500'+	1,000'+
White					
HAL-0750-WHT	1/4" - Polyester Wire Core #8	500'	\$0.72	\$0.66	\$0.60
HAL-0760-WHT	5/16" - Polyester Wire Core #10	500'	\$0.82	\$0.76	\$0.70
HAL-0770-WHT	3/8" - Polyester Wire Core #12	500'	\$1.12	\$1.04	\$0.94
BronzeTone					
HAL-0750-BZT	1/4" - Polyester Wire Core #8	500'	\$0.72	\$0.66	\$0.60
HAL-0760-BZT	5/16" - Polyester Wire Core #10	500'	\$0.84	\$0.76	\$0.70
HAL-0770-BZT	3/8" - Polyester Wire Core #12	500'	\$1.12	\$1.02	\$0.94
Black					
HAL-0750-BLK	1/4" - Polyester Wire Core #8	500'	\$0.72	\$0.66	\$0.60
HAL-0760-BLK	5/16" - Polyester Wire Core #10	500'	\$0.84	\$0.76	\$0.70
HAL-0770-BLK	3/8" - Polyester Wire Core #12	500'	\$1.12	\$1.02	\$0.94
Silver					
HAL-0760-SIL	5/16" - Polyester Wire Core #10	500'	\$0.84	\$0.76	\$0.70

Wire Center Halyard

The strongest of the External Rope Halyard family, Wire Halyard greatly reduces the chance of halyard failure by adding the security of a multi-stranded cable inside a Polyester or Nylon shell.



WHITE POLYESTER WIRE CORE ROPE



BRONZE TONE POLYESTER WIRE CORE ROPE



BLACK POLYESTER WIRE CORE ROPE



SILVER POLYESTER WIRE CORE ROPE

Nylon Halyard

Combining superior elasticity, rot and UV resistance with the ability to more efficiently absorb shock loads, Nylon Halyard provides superior strength and performance.



WHITE NYLON ROPE

Nylon Halyard

PART NUMBER	DESCRIPTION	TYPICAL SPOOL LENGTH	CUT TO LENGTH - PRICE/LINEAL FOOT		
			< 500'	500'+	1,000'+
White					
HAL-0700-WHT	1/4" - Nylon #8	1,000'	\$0.30	\$0.28	\$0.24
HAL-0320-WHT	5/16" - Nylon #10	1,000'	\$0.42	\$0.38	\$0.34
HAL-0420-WHT	3/8" - Nylon #12	500'	\$0.60	\$0.54	\$0.50

Nylon Wire Core Halyard

PART NUMBER	DESCRIPTION	TYPICAL SPOOL LENGTH	CUT TO LENGTH - PRICE/LINEAL FOOT		
			< 500'	500'+	1,000'+
White					
HAL-0250-WHT	1/4" - Nylon Wire Core #8	500'	\$0.72	\$0.66	\$0.60
HAL-0350-WHT	5/16" - Nylon Wire Core #10	500'	\$0.82	\$0.76	\$0.70
HAL-0450-WHT	3/8" - Nylon Wire Core #12	500'	\$1.12	\$1.04	\$0.94



WHITE NYLON WIRE CORE ROPE

Internal Halyard Cam Cleat Rope Assembly

Cam Cleat Rope Assemblies are designed for rope based halyard systems utilizing a Cam Cleat mechanism to secure the Rope Halyard within the flagpole. Constructed with 5/16" Polyester Rope in both Wire Core or Standard designs, assemblies incorporate a stainless steel yoke attached with a machine set aluminum crimp. Each option includes a nylon safety stop for placement below the cam cleat, creating the safest Cam Cleat halyard system in the industry!



CAM CLEAT POLYESTER ROPE ASSEMBLY

COMPLETE CAM CLEAT ROPE HALYARD KIT



For a complete Cam Cleat Rope Replacement System, Order with Rope Assembly. Add two (2) LNK-0300 Stainless Steel Connecting Links (See Page 80), a Counterweight and Retainer Ring Assembly (See Page 73), and two (2) each Flagsnaps and Flagsnap Covers (See Page 72).

Cam Cleat Polyester Rope Assembly

POLE HEIGHT	DESCRIPTION	PART NUMBER	1+		4+		
			White	BronzeTone	White	BronzeTone	
20'	5/16" - Polyester #10	RHA-0200-WHT	\$26	\$23	RHA-0200-BZT	\$26	\$23
25'	5/16" - Polyester #10	RHA-0250-WHT	\$30	\$27	RHA-0250-BZT	\$30	\$27
30'	5/16" - Polyester #10	RHA-0300-WHT	\$35	\$31	RHA-0300-BZT	\$35	\$31
35'	5/16" - Polyester #10	RHA-0350-WHT	\$40	\$36	RHA-0350-BZT	\$40	\$36
40'	5/16" - Polyester #10	RHA-0400-WHT	\$46	\$41	RHA-0400-BZT	\$46	\$41



Cam Cleat Polyester Wire Core Rope Assembly

POLE HEIGHT	DESCRIPTION	PART NUMBER	1+		4+		
			White	BronzeTone	White	BronzeTone	
20'	5/16" - Polyester Wire Core #10	RHA-1200-WHT	\$27	\$24	RHA-1200-BZT	\$27	\$24
25'	5/16" - Polyester Wire Core #10	RHA-1250-WHT	\$32	\$29	RHA-1250-BZT	\$32	\$29
30'	5/16" - Polyester Wire Core #10	RHA-1300-WHT	\$37	\$33	RHA-1300-BZT	\$37	\$33
35'	5/16" - Polyester Wire Core #10	RHA-1350-WHT	\$42	\$37	RHA-1350-BZT	\$42	\$37
40'	5/16" - Polyester Wire Core #10	RHA-1400-WHT	\$48	\$43	RHA-1400-BZT	\$48	\$43



CAM CLEAT POLYESTER WIRE CORE ROPE ASSEMBLY

Wire Halyard

Concord American Flagpole offers a complete line of Wire Cable products for use with Internal Halyard systems. Each are constructed with Stainless Steel Wire Strand Aircraft Cable specifically chosen for its combination of high breaking strength, fatigue resistance, flexibility, and extreme corrosion resistance under the harshest exterior environments. Use with Internal Halyard Winch System Flagpoles only.



Flag Arrangements are constructed of stainless steel aircraft cable with two (2) copper crimps securing stainless steel yokes at each cable termination point. A Stainless Steel Swivel, two (2) Stainless Steel Flagsnaps, and two (2) Stainless Steel Connecting Links complete the assembly.

Flag Arrangement - Complete Assembly
For Use With Wire Cable Based Internal Halyard Winch Systems

FLAG SIZE	FLAGSNAPS	PART NUMBER	1+	4+
2' X 3'	3-1/2" Stainless Steel (2)	FSA-0203	\$72	\$70
3' X 5'	3-1/2" Stainless Steel (2)	FSA-0305	\$79	\$72
4' X 6'	3-1/2" Stainless Steel (2)	FSA-0406	\$87	\$83
5' X 8'	3-1/2" Stainless Steel (2)	FSA-0508	\$89	\$85
6' X 10'	3-1/2" Stainless Steel (2)	FSA-0610	\$101	\$95

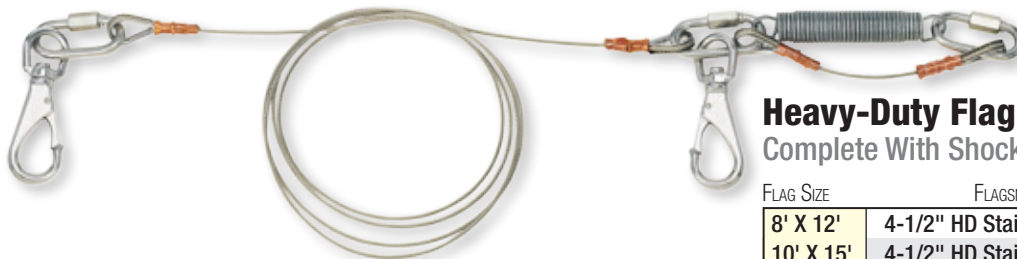

Heavy-Duty Flag Arrangements incorporate a Shock Spring Assembly into our standard Flag Arrangement. Containing a Shock Spring, Shock Spring Safety Cable and additional Stainless Steel Connecting Link, this heavy-duty design for larger flag sizes reduces the strain placed on both halyard components and flags.

Heavy-Duty Flag Arrangement
Complete With Shock Spring Assembly

FLAG SIZE	FLAGSNAPS	PART NUMBER	1+	4+
8' X 12'	4-1/2" HD Stainless Steel (2)	FSA-0812	\$126	\$120
10' X 15'	4-1/2" HD Stainless Steel (2)	FSA-1015	\$132	\$126
12' X 18'	4-1/2" HD Stainless Steel (2)	FSA-1218	\$139	\$132
15' X 25'	4-1/2" HD Stainless Steel (2)	FSA-1525	\$143	\$135
20' X 30'	4-1/2" HD Stainless Steel (2)	FSA-2030	\$147	\$139
20' X 38'	4-1/2" HD Stainless Steel (2)	FSA-2038	\$147	\$139
30' X 50'	4-1/2" HD Stainless Steel (2)	FSA-3050	\$151	\$145
30' X 60'	4-1/2" HD Stainless Steel (2)	FSA-3060	\$151	\$145



The Shock Spring Assembly with Safety Cable contains a Shock Spring and Shock Spring Safety Cable. Use as a replacement Shock Spring Assembly for existing Heavy-Duty Flag Arrangements, or combine with an additional Stainless Steel Connecting Link (See Page 80) to turn any size Flag Arrangement into a Heavy-Duty design.

Shock Spring Assembly
Shock Spring and Safety Cable For Use With Flag Arrangements

PART NUMBER	1+	4+
SPR-0100	\$25	\$23

MULTIPLE FLAG OPTIONS

To fly multiple flags on a single flagpole, order the desired Flag Arrangements and a Stainless Steel Connecting Link (See Page 78). It is recommended that an additional Retainer Ring Assembly be used at the junction of the two (2) Flag Arrangements.



Stainless Steel Connecting Link



Flag Arrangement - Leader Cable Only

For Use With Wire Cable Based Internal Halyard Winch Systems



Flag Arrangement Leader Cables are constructed of 1/8" stainless steel aircraft cable with two (2) copper crimps securing stainless steel yokes at each cable termination point. For use with existing Swivel, Flagnaps and Connecting Links.

FLAG SIZE	DESCRIPTION	PART NUMBER	1+	4+
2' X 3'	1/8" Stainless Steel Cable	FSA-0203-LC	\$13	\$12
3' X 5'	1/8" Stainless Steel Cable	FSA-0305-LC	\$14	\$13
4' X 6'	1/8" Stainless Steel Cable	FSA-0406-LC	\$16	\$15
5' X 8'	1/8" Stainless Steel Cable	FSA-0508-LC	\$18	\$17
6' X 10'	1/8" Stainless Steel Cable	FSA-0610-LC	\$20	\$19
8' X 12'	1/8" Stainless Steel Cable	FSA-0812-LC	\$21	\$20
10' X 15'	1/8" Stainless Steel Cable	FSA-1015-LC	\$23	\$22
12' X 18'	1/8" Stainless Steel Cable	FSA-1218-LC	\$26	\$24
15' X 25'	1/8" Stainless Steel Cable	FSA-1525-LC	\$29	\$27
20' X 30'	1/8" Stainless Steel Cable	FSA-2030-LC	\$47	\$43
20' X 38'	1/8" Stainless Steel Cable	FSA-2038-LC	\$47	\$43
30' X 50'	1/8" Stainless Steel Cable	FSA-3050-LC	\$61	\$58
30' X 60'	1/8" Stainless Steel Cable	FSA-3060-LC	\$61	\$58

Wire Cable Assembly For Wire Cable Based Internal Halyard Winch System Flagpoles

FLAGPOLE HEIGHT	DESCRIPTION	PART NUMBER	1+	4+
25'	1/8" Stainless Steel Wire Cable Assembly	WCA-0250	\$118	\$112
30'	1/8" Stainless Steel Wire Cable Assembly	WCA-0300	\$122	\$116
35'	1/8" Stainless Steel Wire Cable Assembly	WCA-0350	\$130	\$124
40'	1/8" Stainless Steel Wire Cable Assembly	WCA-0400	\$145	\$137
45'	1/8" Stainless Steel Wire Cable Assembly	WCA-0450	\$151	\$145
50'	1/8" Stainless Steel Wire Cable Assembly	WCA-0500	\$174	\$166
60'	1/8" Stainless Steel Wire Cable Assembly	WCA-0600	\$184	\$174
70'	1/8" Stainless Steel Wire Cable Assembly	WCA-0700	\$205	\$195
80'	1/8" Stainless Steel Wire Cable Assembly	WCA-0800	\$217	\$205
100'	1/8" Stainless Steel Wire Cable Assembly	WCA-1000	\$300	\$284
120'	1/8" Stainless Steel Wire Cable Assembly	WCA-1200	\$337	\$321
130'	1/8" Stainless Steel Wire Cable Assembly	WCA-1300	\$375	\$356
140'	1/8" Stainless Steel Wire Cable Assembly	WCA-1400	\$381	\$362
150'	1/8" Stainless Steel Wire Cable Assembly	WCA-1500	\$418	\$397

Internal Halyard Cable Assemblies include a heavy-duty Stainless Steel Swivel which dramatically increases cable life by reducing stress on the halyard. Cable ends use stainless steel yokes which are attached with double heavy-duty copper crimps. Cable Assemblies are built upon our 1/8" SS Wire Cable and includes an attached Stop Sleeve for Winch attachment, two 1" Drilled Nylon Stop Balls, SS Yoke with two (2) heavy-duty Copper Crimps and Cable Swivel.



COMPLETE INTERNAL HALYARD WIRE CABLE ASSEMBLY

For a complete replacement of an Internal Halyard Winch System Assembly, order...

Wire Cable Assembly + Flag Arrangement (See Page 70) + Counterweight (See Page 73) + SS Connecting Link (See Page 80) + Retainer Ring Assembly (See Page 73)

Stainless Steel Wire Cable

For Wire Cable Based Internal Halyard Winch System Flagpoles

SIZE	DESCRIPTION	PART NUMBER	CUT TO LENGTH - PRICE/LINEAL FOOT		
			<500'	500'+	1,000'+
1/8"	Stainless Steel Wire Strand Cable (7x19)	HAL-0500	\$1.64	\$1.42	\$1.18



Flagsnaps

Flagsnaps are used in both Rope and Wire Halyard applications to attach the flag to the flagpole halyard. Nickle Plated Cast Zinc and Cast Brass are good options for the majority of applications, with Stainless Steel options providing superior strength and longevity. Heavy-duty Flagsnaps are preferable for larger flagpole options and in high wind zones. Nylon Snap Hooks are for residential applications only.



SNP-0200

Flagsnaps - Nickel Plated

DESCRIPTION	OVERALL LENGTH	PART NUMBER	1+	12+	48+	96+	300+
Nickel Plated Cast Zinc	3-1/2"	SNP-0200	\$3.04	\$2.94	\$2.84	\$2.70	\$2.50



SNP-1000

SNP-1100

Flagsnaps - Cast Brass

DESCRIPTION	OVERALL LENGTH	PART NUMBER	1+	12+	48+	96+	300+
Cast Brass	3"	SNP-1000	\$4.24	\$4.04	\$3.90	\$3.70	\$3.48
Cast Brass - Heavy-Duty	4-1/2"	SNP-1100	\$8.48	\$8.06	\$7.72	\$7.50	\$6.72



SNP-0700

SNP-0750

SNP-0350

Flagsnaps - Stainless Steel

DESCRIPTION	OVERALL LENGTH	PART NUMBER	1+	12+	48+	96+	300+
Stainless Steel	3-1/2"	SNP-0700	\$16.64	\$15.64	\$15.04	\$14.24	\$13.04
Stainless Steel - Heavy-Duty	3-1/4"	SNP-0750	\$17.60	\$16.74	\$15.98	\$15.20	\$14.14
Stainless Steel - Heavy-Duty	4-1/2"	SNP-0350	\$21.74	\$20.66	\$19.56	\$18.48	\$16.30



SNP-0400

SNP-0450

Flagsnaps - Cast Nylon For Residential Use Only

DESCRIPTION	OVERALL LENGTH	PART NUMBER	1+	12+	48+	96+	300+
Cast Nylon - Residential Use Only	2-3/8"	SNP-0400	\$0.86	\$0.82	\$0.78	\$0.76	\$0.70
Cast Nylon - Residential Use Only	2-3/4"	SNP-0450	\$0.86	\$0.82	\$0.78	\$0.76	\$0.70

SNP-0500-WHT SNP-0500-BZT



SNP-0600-WHT

SNP-0600-BZT

Flagsnap Covers

Neoprene Flagsnap Covers provide wear and shock protection combined with noise reduction.

DESCRIPTION	USE WITH	PART NUMBER	1+	12+	48+	96+	300+
			White				
Snap Cover	3-1/2" Flagsnaps	SNP-0500-WHT	\$2.24	\$2.14	\$2.04	\$1.94	\$1.72
Snap Cover	4-1/2" Flagsnaps	SNP-0600-WHT	\$3.86	\$3.62	\$3.42	\$3.32	\$3.10
			BronzeTone				
Snap Cover	3-1/2" Flagsnaps	SNP-0500-BZT	\$3.32	\$3.22	\$2.98	\$2.88	\$2.78
Snap Cover	4-1/2" Flagsnaps	SNP-0600-BZT	\$3.94	\$3.74	\$3.52	\$3.42	\$3.22



Counterweight

Counterweights are required in Internal Halyard Systems to assist in the lowering of flags. They also ensure the flag hangs and flies properly in winds by keeping the flag taught. Three sizes allow the proper choice of counterweight based on wind zone and flag size flown.



The Industry's Only Patented Counterweight Patent #D594,380

Constructed of steel covered in a thick plastic coating, Concord American Flagpole's patented Counterweights are designed with heavy-duty, horizontal attaching bars. This design more efficiently distributes the stress load when compared to industry standard round-eye ends which concentrate the load in a single location. Dual attachment points in all sizes also provide a significantly increased safety level when compared to single attachment designs. This is the longest lasting, safest Counterweight the industry has to offer!

Counterweights

For Use With All Rope and Wire Internal Halyard Systems

DESCRIPTION	PART NUMBER	PART NUMBER	PART NUMBER	PART NUMBER	1+	6+	12+
	White	BronzeTone	Black	Silver			
3.5 LBS.	CWA-9100-WHT	CWA-9100-BZT	CWA-9100-BLK	CWA-9100-SIL	\$52	\$50	\$48
6.5 LBS.	CWA-9200-WHT	CWA-9200-BZT	CWA-9200-BLK	CWA-9200-SIL	\$66	\$64	\$62
14 LBS.	CWA-9300-WHT	CWA-9300-BZT	CWA-9300-BLK	CWA-9300-SIL	\$101	\$97	\$93

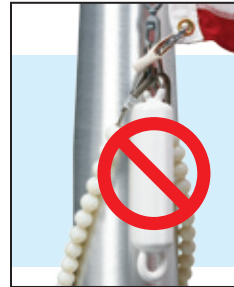

Safety Note:
The Retainer Ring and Rope Assembly or Flag Arrangement should never be attached to the same end of the Counterweight.

CWA-9100-WHT

CWA-9200-WHT

CWA-9300-WHT

Retainer Ring Assembly For Use with Internal or External Halyard Applications

Retainer Ring Assemblies are used to secure the bottom of the flag to the flagpole in Internal Halyard Systems. Additional Retainer Ring Assemblies are also recommended for multi-grommet flags used on larger Internal and External Halyard flagpoles, flags flown in higher wind areas and when flying multiple flags. All Retainer Rings are made using stainless steel cable with stainless steel yokes and two copper crimps at each end for an additional margin of safety. Crimps are machine compressed. The Heavy-Duty Retainer Rings use a combination of 2" diameter rollers and 1" diameter spacer balls for increased product life. Contact Customer Service for custom Retainer Ring Assemblies in sizes up to 72" flagpole butt diameter.



Retainer Ring Assemblies

BUTT DIAMETER	OVERALL LENGTH	CABLE SIZE	BALL DIAMETER	PART NUMBER	PART NUMBER	PART NUMBER	PART NUMBER	1+	6+	12+
				White	BronzeTone	Black	Silver			
4"	24"	1/8"	1" Ball	RRA-0004-WHT	RRA-0004-BZT	RRA-0004-BLK	RRA-0004-SIL	\$46	\$43	\$41
5"	28"	1/8"	1" Ball	RRA-0005-WHT	RRA-0005-BZT	RRA-0005-BLK	RRA-0005-SIL	\$48	\$46	\$43
6"	32"	1/8"	1" Ball	RRA-0006-WHT	RRA-0006-BZT	RRA-0006-BLK	RRA-0006-SIL	\$50	\$48	\$46
7"	36"	1/8"	1" Ball	RRA-0007-WHT	RRA-0007-BZT	RRA-0007-BLK	RRA-0007-SIL	\$54	\$52	\$50
8"	39"	1/8"	1" Ball	RRA-0008-WHT	RRA-0008-BZT	RRA-0008-BLK	RRA-0008-SIL	\$56	\$54	\$52
10"	46"	1/8"	1" Ball	RRA-0010-WHT	RRA-0010-BZT	RRA-0010-BLK	RRA-0010-SIL	\$64	\$62	\$60
12"	53"	1/8"	1" Ball	RRA-0012-WHT	RRA-0012-BZT	RRA-0012-BLK	RRA-0012-SIL	\$70	\$68	\$66

Heavy-Duty Retainer Ring Assemblies

BUTT DIAMETER	OVERALL LENGTH	CABLE SIZE	BALL/ROLLER DIAMETER	PART NUMBER	PART NUMBER	PART NUMBER	1+	6+	12+
				White	BronzeTone	Black			
8"	44"	5/32"	1" Ball / 2" Roller	RRA-0H08-WHT	RRA-0H08-BZT	RRA-0H08-BLK	\$91	\$87	\$84
10"	49"	5/32"	1" Ball / 2" Roller	RRA-0H10-WHT	RRA-0H10-BZT	RRA-0H10-BLK	\$98	\$94	\$90
12"	53"	5/32"	1" Ball / 2" Roller	RRA-0H12-WHT	RRA-0H12-BZT	RRA-0H12-BLK	\$117	\$112	\$108
14"	61"	5/32"	1" Ball / 2" Roller	RRA-0H14-WHT	RRA-0H14-BZT	RRA-0H14-BLK	\$126	\$121	\$116
16"	70"	5/32"	1" Ball / 2" Roller	RRA-0H16-WHT	RRA-0H16-BZT	RRA-0H16-BLK	\$146	\$139	\$134
18"	75"	5/32"	1" Ball / 2" Roller	RRA-0H18-WHT	RRA-0H18-BZT	RRA-0H18-BLK	\$165	\$157	\$151
20"	88"	5/32"	1" Ball / 2" Roller	RRA-0H20-WHT	RRA-0H20-BZT	RRA-0H20-BLK	\$179	\$172	\$166
22"	96"	5/32"	1" Ball / 2" Roller	RRA-0H22-WHT	RRA-0H22-BZT	RRA-0H22-BLK	\$196	\$188	\$180
24"	102"	5/32"	1" Ball / 2" Roller	RRA-0H24-WHT	RRA-0H24-BZT	RRA-0H24-BLK	\$216	\$208	\$201



Cleats

Cleats are used on External Halyard flagpoles as an anchoring location for the Rope Halyard.

*** - Specify Powder Coat Option
 BZT = Bronze Tone
 BLK = Black
 WHT = White
 CLR = Clear



Two (2) Stainless Steel Screws are included with all Cleat options.

Cast Aluminum Cleats

DESCRIPTION	MOUNTING BOLTS CENTER-TO-CENTER	PART NUMBER	1+	6+	18+
Satin					
6"	1-3/4"	CLA-9060	\$9.84	\$9.32	\$8.80
6" Length - With Dealer Insert Area	1-3/4"	CLA-9065	\$12.94	\$12.42	\$11.90
9" Length	2-1/2"	CLA-9090	\$11.90	\$11.40	\$10.88
9" Length - With Dealer Insert Area	2-1/2"	CLA-9095	\$13.98	\$13.46	\$12.94
Powder Coat					
6"	1-3/4"	CLA-9060-***	\$13.98	\$13.46	\$12.94
6" Length - With Dealer Insert Area	1-3/4"	CLA-9065-***	\$18.12	\$17.08	\$16.56
9" Length	2-1/2"	CLA-9090-***	\$18.12	\$17.08	\$16.56
9" Length - With Dealer Insert Area	2-1/2"	CLA-9095-***	\$20.70	\$19.68	\$19.16



CLA-9010

Plated Cleat for Sectional Flagpoles

For Use With Residential Flagpoles

DESCRIPTION	MOUNTING BOLTS CENTER-TO-CENTER	PART NUMBER	1+	4+	18+
Plated Light Duty Cleat	3/4"	CLA-9010	\$1.76	\$1.66	\$1.56

Cleat Mounting Adapter

The Cleat Mounting Adapter is designed for use on existing light poles. It can be permanently mounted with screws (provided) or mounted with hose clamps (by others) for damage-free or temporary Cleat mounting. For Side Mount Truck Kits incorporating the Cleat Mounting Adapter, see Page 67.



CLA-9900

*** - Specify Powder Coat Option
 BZT = Bronze Tone
 BLK = Black
 WHT = White
 CLR = Clear

Cleat Mounting Adapter

Use With 6" CLA-9060 Cleat

DESCRIPTION	MOUNTING BOLTS CENTER-TO-CENTER	PART NUMBER	1+	4+	18+
Satin					
Cleat Mounting Adapter	1-3/4"	CLA-9900	\$6.42	\$6.20	\$5.90
Powder Coat					
Cleat Mounting Adapter	1-3/4"	CLA-9900-***	\$9.52	\$9.22	\$8.80



Halyard Security

Cleat Cover Assemblies, Halyard Cover Assemblies, and Halyard Security Kits (combining the Cleat and Halyard Covers) provide tamper resistant security for External Halyard flagpoles. Available in both Cylinder Lock and Padlock designs containing a sanded Satin finish that is complimentary to the flagpole, all are constructed of heavy, cast aluminum with stainless steel hinges. Cleat and stainless steel attaching screws are included, as well as keys for the Cylinder Lock models (Padlock by others). Installation utilizes the cleat holes. Contact Customer Service for wall mount applications. For replacement Cylinder Locks, see Page 76.

*** - Specify Powder Coat Option
 BZT = Bronze Tone
 BLK = Black
 WHT = White
 CLR = Clear

TOP BRACKET

Cleat Cover - Cylinder Lock

USE WITH POLE DIAMETERS	DESCRIPTION	CLEAT SIZE	PART NUMBER	1+	6+
Satin					
3" to 4"	Cleat Cover - Cylinder Lock	6"	CCA-9040	\$122	\$118
5" to 6"	Cleat Cover - Cylinder Lock	9"	CCA-9030	\$157	\$149
7" to 12"	Cleat Cover - Cylinder Lock	9"	CCA-9020	\$221	\$211
Powder Coat					
3" and 4"	Cleat Cover - Cylinder Lock	6"	CCA-9040-***	\$143	\$135
5" to 6"	Cleat Cover - Cylinder Lock	9"	CCA-9030-***	\$178	\$170
7" to 12"	Cleat Cover - Cylinder Lock	9"	CCA-9020-***	\$242	\$232



Cleat Cover - Padlock

USE WITH POLE DIAMETERS	DESCRIPTION	CLEAT SIZE	PART NUMBER	1+	6+
Satin					
5" to 6"	Cleat Cover - Padlock	9"	CCA-8030	\$161	\$155
7" to 12"	Cleat Cover - Padlock	9"	CCA-8020	\$228	\$219
Powder Coat					
5" to 6"	Cleat Cover - Padlock	9"	CCA-8030-***	\$184	\$176
7" to 12"	Cleat Cover - Padlock	9"	CCA-8020-***	\$248	\$238



Halyard Cover Channel 5' Channel with Top Bracket

USE WITH POLE DIAMETERS	DESCRIPTION	PART NUMBER	1+	6+
Satin				
3" to 4"	Halyard Cover Channel	HBA-9040	\$116	\$110
5" to 6"	Halyard Cover Channel	HBA-9030	\$137	\$132
7" to 12"	Halyard Cover Channel	HBA-9020	\$158	\$153
Powder Coat				
3" to 4"	Halyard Cover Channel	HBA-9040-***	\$124	\$122
5" to 6"	Halyard Cover Channel	HBA-9030-***	\$147	\$143
7" to 12"	Halyard Cover Channel	HBA-9020-***	\$168	\$164

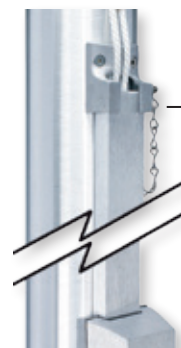

5' HALYARD COVER CHANNEL

BRACKET INCLUDES SAFETY CHAIN AND HARDWARE

SECURITY CLEAT COVER

Halyard Security Kit Cleat Cover, 5' Halyard Channel and Top Bracket

USE WITH POLE DIAMETERS	DESCRIPTION	USES CLEAT BOX / HALYARD CHANNEL	PART NUMBER	1+	6+
Satin					
3" to 4"	Halyard Security Kit - Cylinder Lock	CCA-9040 / HBA-9040	CHA-9200	\$238	\$228
5" to 6"	Halyard Security Kit - Cylinder Lock	CCA-9030 / HBA-9030	CHA-9000	\$294	\$282
7" to 12"	Halyard Security Kit - Cylinder Lock	CCA-9020 / HBA-9020	CHA-9050	\$331	\$319
5" to 6"	Halyard Security Kit - Padlock	CCA-8030 / HBA-8030	CHA-8000	\$294	\$282
7" to 12"	Halyard Security Kit - Padlock	CCA-8020 / HBA-8020	CHA-8050	\$331	\$319
Powder Coat					
3" to 4"	Halyard Security Kit - Cylinder Lock	CCA-9040-*** / HBA-9040-***	CHA-9200-***	\$267	\$259
5" to 6"	Halyard Security Kit - Cylinder Lock	CCA-9030-*** / HBA-9030-***	CHA-9000-***	\$325	\$313
7" to 12"	Halyard Security Kit - Cylinder Lock	CCA-9020-*** / HBA-9020-***	CHA-9050-***	\$375	\$360
5" to 6"	Halyard Security Kit - Padlock	CCA-8030-*** / HBA-8030-***	CHA-8000-***	\$325	\$313
7" to 12"	Halyard Security Kit - Padlock	CCA-8020-*** / HBA-8020-***	CHA-8050-***	\$375	\$360



Cam Cleats

Cam Cleats are used in Internal Rope Halyard Systems, securely holding the halyard behind a heavy-duty cam action cleat. Maximum Rope diameter is 5/16".

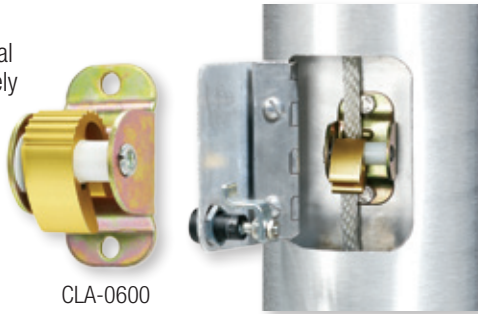

CLA-0600

Cam Cleats For Use With Rope Based Internal Halyard Systems

DESCRIPTION	MOUNTING BOLTS		1+	6+	18+
	CENTER-TO-CENTER	PART NUMBER			
Cam Cleat	2"	CLA-0600	\$20	\$19	\$18

Winches

The Flagpole Winch provides a secure means of manually raising and lowering the flag in Internal Wire Cable Halyard flagpoles. Manufactured from stainless steel, this style of gearless winch was designed specifically for the flagpole industry, providing a smooth, easy method for raising, lowering, and stopping the flag at any height. The brake mechanism utilizes large bronze brake shoes which automatically engage when the handle stops rotating and is removed.

Winches For Use With Wire Based Internal Halyard Systems

DESCRIPTION	MOUNTING BOLTS		1+	6+	18+
	CENTER-TO-CENTER	PART NUMBER			
<i>WINCH</i>					
Small Winch - For Flagpoles Up To 45'	3-1/2"	WCH-0101	\$441	\$418	\$410
Large Winch - For Flagpoles 50' - 80'	3-1/2"	WCH-0201	\$456	\$439	\$431
Extra-Large Winch - Special Applications Only	*	WCH-0301	\$646	\$621	\$609
<i>Winch Handle</i>					
7/16" Handle for WCH-101, WCH-201, WCH-301	-	WCH-0401	\$31	\$29	\$25

*Four-Bolt Pattern - 3-1/2" h x 3-1/4" w



WCH-0101



WCH-0401



LOK-0100



LOK-0300



LOK-1510

LOK-5645
LOK-6696

Cylinder Locks Replacement Locks for Doors in Internal Halyard Flagpoles

DESCRIPTION	PART NUMBER	1+	6+
<i>INDEPENDENCE, SENTRY II, AND EXTREME XIRW FLAGPOLES</i>			
Cylinder Door Lock with Keys	LOK-0100	\$19	\$18
Replacement Keys for LOK-0100	LOK-0410	\$11	\$10
<i>Sentry Flagpoles</i>			
Cylinder Door Lock with Keys	LOK-0300	\$17	\$16
Replacement Keys for LOK-0300	LOK-0310	\$11	\$10
<i>Titan, Monarch, and Extreme XIWW Flagpoles</i>			
Compression Door Lock with Key - 5"-7" Butt Diameters	LOK-5645	\$39	\$37
Compression Door Lock with Key - 8"+ Butt Diameters	LOK-6696	\$41	\$39
Replacement Key for LOK-5645 and LOK-6696	LOK-5646	\$11	\$10
<i>American Flagpole Cam Cleat & Winch Flagpoles Prior To 2004</i>			
Cylinder Lock with Keys	LOK-1510	\$15	\$13



LOK-0200



LOK-5595

Cylinder Locks Replacement Locks for External Halyard Cylinder Lock Cleat Covers

DESCRIPTION	PART NUMBER	1+	6+
<i>CLEAT COVERS CCA-9040, CCA-9030, AND CCA-9020 (SEE PAGE 75)</i>			
Cylinder Door Lock with Keys	LOK-0200	\$19	\$17
Replacement Keys for LOK-0200	LOK-0410	\$11	\$10
<i>Cleat Covers - American Flagpole Products Prior to 2018</i>			
Cylinder Door Lock with Keys	LOK-5595	\$19	\$17
Replacement Keys for LOK-5595	LOK-0310	\$11	\$10

Ground Sleeves - Steel Corrugated Steel with Steel Lightning Spike Two-Piece Design

Corrugated Steel Ground Sleeves with Steel Lightning Spike are designed for use in Ground Set flagpole installations (See Page 14). Our superior 2-piece design contains an upper section manufactured of galvanized 16-gauge corrugated steel tube, a thick steel base plate, and steel centering wedges welded into the base to assist in plumb installations of the flagpole. The lower section incorporates a threaded top 3/4" diameter steel grounding spike with 6" x 6" steel setting plate, allowing the concrete foundation to completely surround the sleeve. Ground Sleeves for flagpoles up to 75' can be shipped via UPS and Fed Ex, providing significant savings over competitor's one piece designs. Contact Customer Service for custom sizes, larger sizes, or special applications.

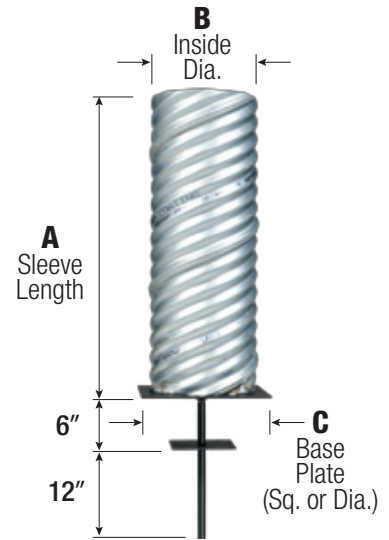
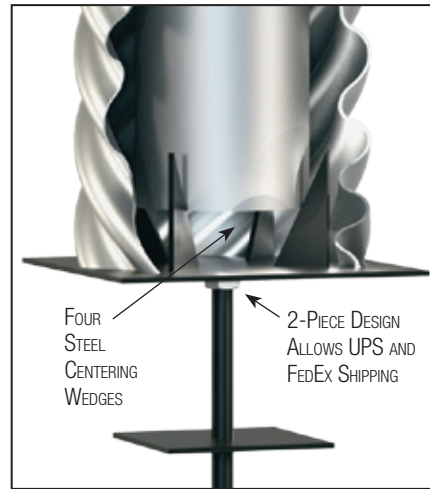

FLAGPOLE HEIGHT	"A" SLEEVE LENGTH	FOR USE WITH 4" BUTT DIAMETER FLAGPOLES SLEEVE DIA. "B" = 6" BASE PLATE "C" = 8"		FOR USE WITH 5" BUTT DIAMETER FLAGPOLES SLEEVE DIA. "B" = 8" BASE PLATE "C" = 10"		FOR USE WITH 6-7" BUTT DIAMETER FLAGPOLES SLEEVE DIA. "B" = 10" BASE PLATE "C" = 12"		FOR USE WITH 8" BUTT DIAMETER FLAGPOLES SLEEVE DIA. "B" = 12" BASE PLATE "C" = 14"		FOR USE WITH 10-12" BUTT DIAMETER FLAGPOLES SLEEVE DIA. "B" = 15" BASE PLATE "C" = 16"	
		PART NUMBER	1+	PART NUMBER	1+	PART NUMBER	1+	PART NUMBER	1+	PART NUMBER	1+
20'	2'	GCA-2006	\$177	GCA-2008	\$188	GCA-2010	\$191				
25'	2'-6"	GCA-2506	\$188	GCA-2508	\$194	GCA-2510	\$200				
30'	3'	GCA-3006	\$193	GCA-3008	\$199	GCA-3010	\$205	GCA-3012	\$228		
35'	3'-6"			GCA-3508	\$206	GCA-3510	\$211	GCA-3512	\$238		
40'	4'			GCA-4008	\$210	GCA-4010	\$234	GCA-4012	\$263	GCA-4015	\$290
45'	4'-6"					GCA-4510	\$248	GCA-4512	\$286	GCA-4515	\$300
50'	5'					GCA-5010	\$259	GCA-5012	\$308	GCA-5015	\$343
55'	5'-6"									GCA-5515	\$362
60'	6'									GCA-6015	\$381
65'	6'-6"									GCA-6515	\$414
70'	7'									GCA-7015	\$451
75'	7'-6"									GCA-7515	\$466
80'	8'									GCA-8015	\$505

*GCA Ground Sleeves May Be Combined For Quantity Discounts: 6+...Deduct 5%.

Ground Sleeves - PVC

PVC Ground Sleeves aid in the proper Ground Set installation of smaller residential and commercial flagpoles. They are not recommended for use on installations exceeding 35', flagpoles having larger wall thicknesses, flagpoles located in high wind regions, or in flagpoles applications flying oversized or multiple flags. See Page 14, Ground Set Foundations, for more information.



FLAGPOLE HEIGHT	SLEEVE LENGTH	FOR USE WITH 2" BUTT DIAMETER FLAGPOLES SLEEVE DIA. (I.D.) = 2" NOM.		FOR USE WITH 2-1/2-3" BUTT DIAMETER FLAGPOLES SLEEVE DIA. (I.D.) = 4"		FOR USE WITH 4" BUTT DIAMETER FLAGPOLES SLEEVE DIA. (I.D.) = 6"		FOR USE WITH 5" BUTT DIAMETER FLAGPOLES SLEEVE DIA. (I.D.) = 8"	
		PART NUMBER	1+	PART NUMBER	1+	PART NUMBER	1+	PART NUMBER	1+
15'	1'-6"			GST-1504	\$17				
20'	2'	GST-2002	\$9	GST-2004	\$18	GST-2006	\$33	GST-2008	\$47
25'	2'-6"			GST-2504	\$19	GST-2506	\$40	GST-2508	\$52
30'	3'					GST-3006	\$48	GST-3008	\$57
35'	3'-6"							GST-3508	\$62

*PVC Ground Sleeves May Be Combined For Quantity Discounts: 6+...Deduct 5%.

Lightning Rod Kit

Lightning Rod Kits are constructed of 7-strand, 1/2" diameter x 6' long aluminum cable and 5/8" diameter x 5' long copper clad rod. Kit includes Drill and Tap Kit, assembly hardware and installation instructions for field installation.

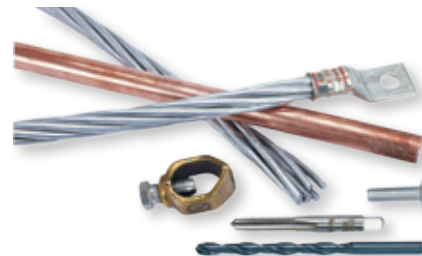

DESCRIPTION	PART NUMBER	1+	6+
Lightning Rod Kit	LRK-9019	\$170	\$161



Spun Collars

Our most common style flash collar, Spun Aluminum Collars are manufactured to exacting specifications from the highest quality materials. They provide the perfect finishing touch for both Ground Set and Shoe Base installations. Split, two-piece collars are available for replacing or adding a collar to existing flagpoles. I.D. approximately 1/8" wider than Butt Diameter.

***** - Specify Finish**

- SAT = Satin
- BZT = BronzeTone Powder Coat
- BLK = Black Powder Coat
- WHT = White Powder Coat



All Spun and Cast Collars are Available in Both 1-Piece and 2-Piece Designs

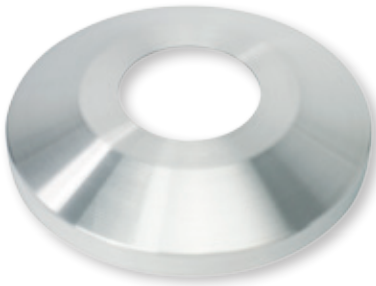

STYLE A - FC11
SPUN ALUMINUM

.080" Thickness - 33% Stronger Than Standard Competitor's Products

STYLE A - FC11 - Spun Aluminum 1-Piece Construction

BUTT DIA.	OUTSIDE DIA.	PART NUMBER	1+	6+	12+	PART NUMBER	1+	6+	12+
		Satin				Powder Coat			
2"	12"	COL1-A02S	\$35	\$34	\$32	COL1-A02S-***	\$48	\$47	\$46
2-1/2"	12"	COL1-A25S	\$35	\$34	\$32	COL1-A25S-***	\$48	\$47	\$46
3"	12"	COL1-A03S	\$35	\$34	\$32	COL1-A03S-***	\$48	\$47	\$46
3-1/2"	12"	COL1-A35S	\$35	\$34	\$32	COL1-A35S-***	\$48	\$47	\$46
4"	12"	COL1-A04S	\$35	\$34	\$32	COL1-A04S-***	\$48	\$47	\$46
5"	14"	COL1-A05S	\$37	\$36	\$34	COL1-A05S-***	\$51	\$50	\$48
5-1/2"	14"	COL1-A55S	\$37	\$36	\$34	COL1-A55S-***	\$51	\$50	\$48
6"	14"	COL1-A06S	\$37	\$36	\$34	COL1-A06S-***	\$51	\$50	\$48
7"	14"	COL1-A07S	\$37	\$36	\$34	COL1-A07S-***	\$51	\$50	\$48
8"	18"	COL1-A08S	\$61	\$59	\$57	COL1-A08S-***	\$80	\$78	\$76
10"	18"	COL1-A10S	\$61	\$59	\$57	COL1-A10S-***	\$80	\$78	\$76
12"	18"	COL1-A12S	\$61	\$59	\$57	COL1-A12S-***	\$80	\$78	\$76

Add \$80 for a Split 2-Piece version of the Style A - FC11 Spun Aluminum Collar. Modify Part # COL1 to COL2 (Example Part #: COL2-A02S).



STYLE B
SPUN ALUMINUM

For Use With Shoe Base Flagpole Applications 

STYLE B - Spun Aluminum 1-Piece Construction

BUTT DIA.	OUTSIDE DIA.	PART NUMBER	1+	6+	12+	PART NUMBER	1+	6+	12+
		Satin				Powder Coat			
4"	9-7/8"	COL1-B04S	\$70	\$67	\$65	COL1-B04S-***	\$95	\$90	\$87
5"	9-7/8"	COL1-B05S	\$75	\$70	\$69	COL1-B05S-***	\$100	\$95	\$92
6"	13"	COL1-B06S	\$78	\$73	\$72	COL1-B06S-***	\$105	\$99	\$96
7"	14-1/8"	COL1-B07S	\$79	\$75	\$73	COL1-B07S-***	\$107	\$100	\$97
8"	15-1/16"	COL1-B08S	\$81	\$77	\$76	COL1-B08S-***	\$109	\$104	\$100
10"	18-1/8"	COL1-B10S	\$109	\$104	\$101	COL1-B10S-***	\$147	\$140	\$135

Add \$105 for a Split 2-Piece version of the Style B Spun Aluminum Collar. Modify Part # COL1 to COL2 (Example Part #: COL2-B04S).

Cast Collars

Our offering of heavy-duty Cast Aluminum Collars provide project owners the strongest and most durable collar offered in the industry today! Cast from Aluminum Alloy, these 1/4" thick cast collars are designed to withstand the harshest of environments. Offered in both 1-piece and 2-piece designs, they are perfect as either an upgrade to a new flagpole purchase or as a replacement or addition to an existing flagpole. *I.D. approximately 1/8" wider than Butt Diameter.*

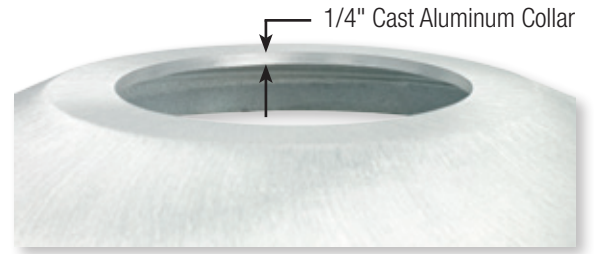

STYLE A - FC11 - Cast Aluminum

1-Piece Construction

BUTT DIA.	OUTSIDE DIA.	PART NUMBER	1+	6+	12+	PART NUMBER	1+	6+	12+
		Satin				Powder Coat			
3"	14"	COL1-A03C	\$92	\$88	\$86	COL1-A03C-***	\$114	\$111	\$105
3-1/2"	14"	COL1-A35C	\$92	\$88	\$86	COL1-A35C-***	\$114	\$111	\$105
4"	14"	COL1-A04C	\$92	\$88	\$86	COL1-A04C-***	\$114	\$111	\$105
5"	14"	COL1-A05C	\$92	\$88	\$86	COL1-A05C-***	\$114	\$111	\$105
5-1/2"	14"	COL1-A55C	\$92	\$88	\$86	COL1-A55C-***	\$114	\$111	\$105
6"	14"	COL1-A06C	\$92	\$88	\$86	COL1-A06C-***	\$114	\$111	\$105
7"	14"	COL1-A07C	\$92	\$88	\$86	COL1-A07C-***	\$114	\$111	\$105
8"	18"	COL1-A08C	\$229	\$217	\$213	COL1-A08C-***	\$290	\$275	\$267
10"	18"	COL1-A10C	\$229	\$217	\$213	COL1-A10C-***	\$290	\$275	\$267
12"	18"	COL1-A12C	\$229	\$217	\$213	COL1-A10C-***	\$290	\$275	\$267

*** - Specify Finish
 SAT = Satin
 BZT = BronzeTone Powder Coat
 BLK = Black Powder Coat
 WHT = White Powder Coat

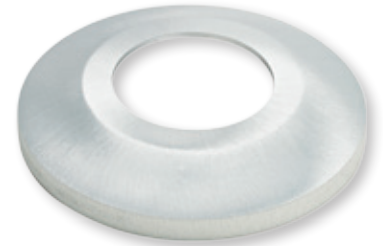

STYLE A - FC11
CAST ALUMINUM

Add \$65 for a Hidden Bolt, Split 2-Piece version of the Style A - FC11 Cast Collar.
 Modify Part # COL1 to COL2 (Example Part #: COL2-A03C).

STYLE C - FC15 - Cast Aluminum

1-Piece Construction

BUTT DIA.	OUTSIDE DIA.	PART NUMBER	1+	6+	12+	PART NUMBER	1+	6+	12+
		Satin				Powder Coat			
5"	20"	COL1-C05C	\$483	\$460	\$445	COL1-C05C-***	\$527	\$501	\$485
5-1/2"	20"	COL1-C55C	\$483	\$460	\$445	COL1-C55C-***	\$527	\$501	\$485
6"	20"	COL1-C06C	\$483	\$460	\$445	COL1-C06C-***	\$527	\$501	\$485
7"	20"	COL1-C07C	\$483	\$460	\$445	COL1-C07C-***	\$527	\$501	\$485
8"	20"	COL1-C08C	\$483	\$460	\$445	COL1-C08C-***	\$527	\$501	\$485
10"	24"	COL1-C10C	\$620	\$589	\$570	COL1-C10C-***	\$652	\$620	\$600
12"	24"	COL1-C12C	\$620	\$589	\$570	COL1-C12C-***	\$652	\$620	\$600

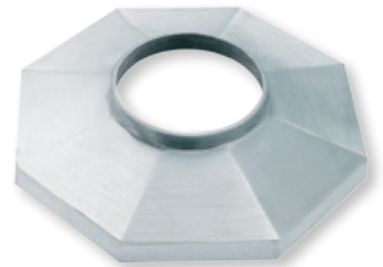

STYLE C - FC15
CAST ALUMINUM

Add \$105 for a Hidden Bolt, Split 2-Piece version of the Style C - FC15 Cast Collar.
 Modify Part # COL1 to COL2 (Example Part #: COL2-C05C).

STYLE F - FC121 - Cast Aluminum

1-Piece Construction

BUTT DIA.	OUTSIDE DIA.	PART NUMBER	1+	6+	12+	PART NUMBER	1+	6+	12+
		Satin				Powder Coat			
5"	22"	COL1-F05C	\$448	\$425	\$412	COL1-F05C-***	\$522	\$496	\$480
5-1/2"	22"	COL1-F55C	\$448	\$425	\$412	COL1-F55C-***	\$522	\$496	\$480
6"	22"	COL1-F06C	\$448	\$425	\$412	COL1-F06C-***	\$522	\$496	\$480
7"	22"	COL1-F07C	\$448	\$425	\$412	COL1-F07C-***	\$522	\$496	\$480
8"	22"	COL1-F08C	\$448	\$425	\$412	COL1-F08C-***	\$522	\$496	\$480
10"	22"	COL1-F10C	\$448	\$425	\$412	COL1-F10C-***	\$522	\$496	\$480



STYLE F - FC121
CAST ALUMINUM

Add \$105 for a Hidden Bolt, Split 2-Piece version of the Style F - FC121 Cast Collar.
 Modify Part # COL1 to COL2 (Example Part #: COL2-F05C).



LNK-0300

Connecting Link 5/16" Thread-Lock Stainless Steel

DESCRIPTION	PART NUMBER	1+	6+	12+
Connecting Link - Stainless Steel	LNK-0300	\$10.88	\$10.36	\$9.68



YOK-0014
YOK-0516

Cable Yoke Stainless Steel

DESCRIPTION	PART NUMBER	1+	12+	36+
Yoke - Stainless Steel - 1/4"	YOK-0014	\$2.50	\$2.38	\$2.28
Yoke - Stainless Steel - 5/16"	YOK-0516	\$3.62	\$3.46	\$3.32



CRP-0100



CRP-0500



CRP-0520

Crimps Cable and Rope

DESCRIPTION	PART NUMBER	1+	25+	100+
1/8" Cable Crimp - Copper	CRP-0100	\$0.78	\$0.72	\$0.70
5/16" Rope Crimp - Aluminum	CRP-0500	\$1.74	\$1.64	\$1.54
3/8" Rope Crimp - Aluminum	CRP-0520	\$2.28	\$2.18	\$2.08



CRP-0200

Cable Stop For Use With Wire Cable Winch Systems

DESCRIPTION	PART NUMBER	1+	6+	12+
1/8" Cable Stop Crimp - Copper	CRP-0200	\$0.92	\$0.88	\$0.84



BAL-1000-WHT



BAL-1000-BZT



BAL-1000-SIL



BAL-1000-BKT

Retainer Ring Balls

DESCRIPTION	PART NUMBER	1+	100+	300+
1" White Nylon Ball - Drilled	BAL-1000-WHT	\$0.78	\$0.68	\$0.62
1" Bronzestone Nylon Ball - Drilled	BAL-1000-BZT	\$0.78	\$0.68	\$0.62
1" Black Nylon Ball - Drilled	BAL-1000-BLK	\$0.82	\$0.72	\$0.66
1" Silver Nylon Ball - Drilled	BAL-1000-SIL	\$0.82	\$0.72	\$0.66



SWL-0100

Cable Swivel Stainless Steel

DESCRIPTION	PART NUMBER	1+	6+	12+
Cable Swivel - Stainless Steel	SWL-0100	\$15.22	\$14.18	\$13.14

Snap Hook Assembly

The Snap Hook Assembly consists of 1/8" stainless steel wire cable, Stop Sleeves (attached to each end), Wire Clamp and Stainless Steel Snap Hook. This Assembly is used to attach large, multi-grommeted flags or when flying multiple flags. Use with Wire Cable Winch Systems only.



SHA-9451

Snap Hook Assembly For Use With Wire Cable Winch Systems

DESCRIPTION	PART NUMBER	1+	6+	12+
Snap Hook Assembly	SHA-9451	\$16	\$13	\$12



RWC-9027

Wire Halyard Clamp

DESCRIPTION	PART NUMBER	1+	6+	12+
Rope Wire Clamp	RWC-9027	\$1.04	\$1.00	\$0.98



Screws and Drill & Tap Set

Stainless Steel Screws are designed for use with both Cast Cleats (See Page 74) and Flagpole Top Adaptors (See Page 62). Drill and Tap Kit contains bit and 5/16"-18NC Tap.

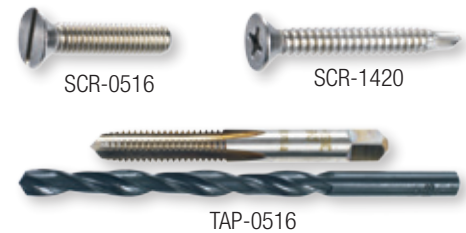

DESCRIPTION	PART NUMBER	1+	6+	12+
Stainless Steel 1-1/2" Cleat Screw - 5/16"-18NC	SCR-0516	\$0.54	\$0.44	\$0.42
SS 2" Self Tapping Cleat Screw - 1/4"-20NC	SCR-1420	\$1.04	\$0.98	\$0.94
Drill & Tap - 5/16"-18NC	TAP-0516	\$13.98	\$12.94	\$11.90

Wall Anchorage For Use With Outrigger and Vertical Wall Mount Flagpole Systems*

The Wall Anchorage Kit consists of a 3/4"-10NC x 18" Stainless Steel through bolt, 3/4" Stainless Steel Nuts, Spring Lock Washers, Flat Lock Washers, and 1-1/4" x 14" Schedule 10 Aluminum pipe. Each Kit contains one (1) bolt.



DESCRIPTION	PART NUMBER	1+	6+	12+
Wall Anchorage Kit - 3/4" Dia. Through Bolt	WAK-9421	\$55	\$51	\$50
4" x 4" Backing Plate - 7/8" Dia. Hole	WAK-9451	\$11	\$10	\$9

***Note:** These products are offered as component pieces only. Installation methods should always be approved by a Structural Engineer based on individual jobsite variables.

Outrigger Retainer Kit

The Outrigger Retainer Kit allows the tension on the halyard to be relieved, facilitating both the raising and lowering of the flag while providing a way to unfurl a flag wrapped around an Outrigger Wall Mount Shaft. The system is offered as a complete kit containing the Pulley Block (attachment hardware by others), 75' HAL-0710-WHT Halyard, CLA-9090 9" Cleat, TMB-0200 Stainless Steel Yoke, CRP-0520 Aluminum Crimp, and LNK-0300 Connecting Link.



DESCRIPTION	PART NUMBER	1+	6+	12+
Outrigger Retainer Kit	ORK-1000	\$62	\$57	\$56

Pulleys / Eyebolt Single and Double Swivel

Pulleys are constructed of zinc-plated housings, nylon pulleys and brass connecting pins. Eyebolt is 3/8"-16NC x 4-3/4" Long Stainless Steel.

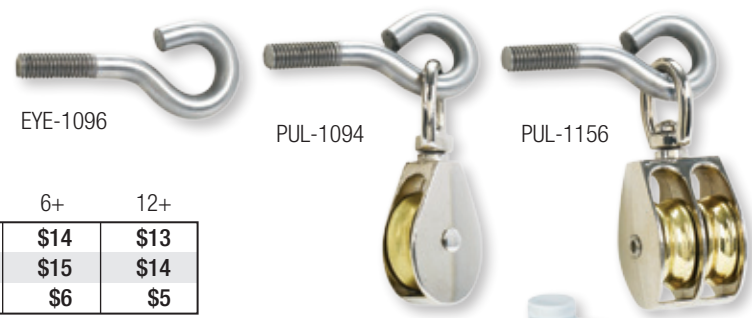

DESCRIPTION	PART NUMBER	1+	6+	12+
Single Pulley - With Swivel and Eyebolt	PUL-1094	\$15	\$14	\$13
Double Pulley - With Swivel and Eyebolt	PUL-1156	\$16	\$15	\$14
Eyebolt - 3/8"	EYE-1096	\$7	\$6	\$5

Aluminum Cleaner

Formulated to remove oxidation stains from aluminum without the use of abrasives or wire brushing. One Gallon container requires no mixing.

CLN-9935



DESCRIPTION	PART NUMBER	1+	6+	12+
Ox-Out Aluminum Cleaner - 1 Gallon	CLN-9935	\$88	\$83	\$81

Touch Up Paint Specify Color

Touch-Up Paints from Concord American Flagpole contain the highest quality spray paint custom matched to our most popular Powder Coat colors.

PNT-0300-***



*** - Specify Powder Coat Option
BZT = Bronze Tone WHT = White
BLK = Black

DESCRIPTION	PART NUMBER	1+	6+	12+
Touch Up Paint - 12 oz. Aerosol Can - Standard Colors	PNT-0300-***	\$25.00	\$23.80	\$22.50



American Beacon

The Proper Way to Light Your Flag!

An American Beacon Flagpole Lighting Package unites the patented Beacon Down Light with a Lifetime Pole Shaft Warranty from the industry's oldest and most recognized name in aluminum flagpoles... Concord American Flagpole.

The American Beacon is the most environmentally correct way to illuminate flags during night hours. For the first time, flags can be properly lit during nighttime hours without lighting adjoining property and the night sky. *Patent #7,275,495.*

- Minimize Light Pollution
- Rotates With The Flag, Focusing All Light On The Flag as the Wind Blows it Around the Flagpole
- Energy Efficient LED Bulbs Provide Years of Maintenance-Free Use
- Available for Flagpole Heights of 20' to 80'
- Residential Options Available
- Solar Packages Available
- Made in the USA

The Proper Way to Light Your Flag!

Official U.S. Flag Code

Section 2

A. "...when a patriotic effect is desired, the flag may be displayed twenty-four hours a day if properly illuminated during the hours of darkness."

**Manufactured In
USA**



Intertek
4010565
Conforms to UL STD 1598

International Dark Sky Association (IDA) is the recognized authority on light pollution and is the leading organization combating light pollution worldwide.

The IDA Device Seal of Approval was created to recognize a wide range of Dark Sky Friendly Technologies that aid in the mitigation of light pollution.

The American Beacon is certified by the International Dark Sky Association (IDA) as an IDA Approved Dark-Sky Friendly Fixture.



*IDA Approved Dark-Sky
Friendly Fixture*



American Beacon – Internal Halyard Series

The American Beacon Internal Halyard Series provides lighting options for both Winch and Cam Cleat flagpoles systems in heights from 20' – 80'. These options provide the most environmentally correct way for flagpole illumination, properly lighting the flag during nighttime hours without lighting adjoining properties and the night sky!

- Internal Halyard 359° Revolving Truck
- 12 Volt System With Driver Contained Inside the Truck
- Warm White, 3000K LED Lights Rated for 25,000+ Hours
- 110V / 120V Input, 12 Volt Output
- Wire Provided For Flagpole Height Plus 10' (Flagpole Height To Be Provided in Part #)
- Standard 1-1/4" NPT Spindle
- Solar Options Available
- Standard 1/2"-13NC Top Drilling on Dual and Quad Internal Winch Models (5/8"-11NC Available Upon Request)

Patent #7,275,495

*** - Specify Finish Option
 SAT = Satin
 BZT = BronzeTone Powder Coat
 BLK = Black Powder Coat
 WHT = White Powder Coat

Internal Halyard Beacon - Dual Light Winch System - Wire Halyard

FLAGPOLE MAX TOP DIA.	DESCRIPTION	TOTAL LUMENS	BEACON SIZE	PART NUMBER	1+ SATIN	1+ POWDER COAT
				Beacon		
3.5"	BEACON - Dual Light	500	6" Dia.	ABW2-##FS-***	\$3,351	\$3,442
4"	BEACON - Dual Light	500	8" Dia.	ABW2-##4S-***	\$3,782	\$3,873
				Beacon Plus		
3.5"	BEACON PLUS - Dual Light	572	6" Dia.	ABW2-##FP-***	\$3,869	\$3,960
4"	BEACON PLUS - Dual Light	572	8" Dia.	ABW2-##4P-***	\$4,299	\$4,390

Example Part #: ABW2-30FS-SAT
 American Beacon Internal Halyard Dual Light,
 30' Flagpole, 3.5" Max Top Flagpole Diameter,
 Standard Beacon, Satin Finish

= Specify Flagpole Height (20, 25, 30 etc.)
 *** = Specify Finish Option



Beacon Plus - Dual Light
 Illuminate the flag while at rest!
 The Internal Halyard, Dual Light Beacon Plus incorporates two vertical 2 Watt MR8 LED bulbs.

Internal Halyard Beacon - Quad Light Winch System - Wire Halyard

FLAGPOLE MAX TOP DIA.	DESCRIPTION	TOTAL LUMENS	BEACON SIZE	PART NUMBER	1+ SATIN	1+ POWDER COAT
				Beacon		
4"	BEACON - Quad Light	1000	8" Dia.	ABW4-##4S-***	\$4,430	\$4,521
				Beacon Plus		
4"	BEACON PLUS - Quad Light	1072	8" Dia.	ABW4-##4P-***	\$4,947	\$5,038

Example Part #: ABW4-604P-BZT
 American Beacon Internal Halyard Quad Light,
 60' Flagpole, 4" Max Top Flagpole Diameter,
 Beacon Plus, BronzeTone Powder Coat Finish

= Specify Flagpole Height (20, 25, 30 etc.)
 *** = Specify Finish Option



Beacon Plus - Quad Light
 Illuminate the flag while at rest!
 The Internal Halyard, Quad Light Beacon Plus incorporates two vertical 2 Watt MR8 LED bulbs.

Internal Halyard Cam Cleat Beacon Rope Halyard - Cam Cleat System

FLAGPOLE TOP DIAMETER	BALL COLOR ANODIZED FINISH	DESCRIPTION	TOTAL LUMENS	BEACON SIZE	PART NUMBER	1+ SATIN	1+ POWDER COAT
					Beacon		
3"	Gold	Cam Cleat BEACON	500	8" Dia.	ABCC-##3S-GLD-***	\$3,014	\$3,105
3.5"	Gold	Cam Cleat BEACON	500	8" Dia.	ABCC-##FS-GLD-***	\$3,078	\$3,169
4"	Gold	Cam Cleat BEACON	500	8" Dia.	ABCC-##4S-GLD-***	\$3,790	\$3,881
3"	Silver	Cam Cleat BEACON	500	8" Dia.	ABCC-##3S-SIL-***	\$3,014	\$3,105
3.5"	Silver	Cam Cleat BEACON	500	8" Dia.	ABCC-##FS-SIL-***	\$3,078	\$3,169
4"	Silver	Cam Cleat BEACON	500	8" Dia.	ABCC-##4S-SIL-***	\$3,790	\$3,881
					Beacon Plus		
3"	Gold	Cam Cleat BEACON PLUS	572	8" Dia.	ABCC-##3P-GLD-***	\$3,531	\$3,623
3.5"	Gold	Cam Cleat BEACON PLUS	572	8" Dia.	ABCC-##FP-GLD-***	\$3,596	\$3,687
4"	Gold	Cam Cleat BEACON PLUS	572	8" Dia.	ABCC-##4P-GLD-***	\$4,308	\$4,399
3"	Silver	Cam Cleat BEACON PLUS	572	8" Dia.	ABCC-##3P-SIL-***	\$3,531	\$3,623
3.5"	Silver	Cam Cleat BEACON PLUS	572	8" Dia.	ABCC-##FP-SIL-***	\$3,596	\$3,687
4"	Silver	Cam Cleat BEACON PLUS	572	8" Dia.	ABCC-##4P-SIL-***	\$4,308	\$4,399

Example Part #: ABCC-25FS-GLD-BLK American Beacon Internal Halyard Cam Cleat, 25' Flagpole, 3.5" Max Top Flagpole Diameter, Standard Beacon, Gold Anodized Ball, Black Powder Coat Finish

= Specify Flagpole Height (20, 25, 30 etc.)
 *** = Specify Finish Option
 (Specified Finishes Applied to Truck Only.)

- 8" Gold or Silver Anodized Ball Only
- Accepts up to 5/16" Rope Halyard



Beacon Plus - Internal Cam Cleat
 Illuminate the flag while at rest! The Heavy-Duty External Halyard Beacon Plus incorporates two vertical 2 Watt MR8 bulbs.



American Beacon – External Halyard Series

The American Beacon External Halyard Series provide lighting options for flagpole systems in heights from 20' – 50'. These options provide the most environmentally correct way for flagpole illumination, properly lighting the flag during nighttime hours without lighting adjoining properties and the night sky!

- External Halyard 359° Revolving Truck
- 12 Volt System With Driver Contained Inside the Ball
- Warm White, 3000K LED Lights Rated for 25,000+ Hours
- 110V / 120V Input, 12 Volt Output
- Wire Provided For Flagpole Height Plus 10' (Flagpole Height To Be Provided in Part #)
- Standard, 1-1/4" NPT Spindle
- Solar Options Available
- Double Truck Systems are NOT Available

Patent #7,275,495

*** - Specify Finish Option
 SAT = Satin
 BZT = BronzeTone Powder Coat
 BLK = Black Powder Coat
 WHT = White Powder Coat



External Halyard Beacon - Standard Rope Halyard - Revolving - Spindle Truck

FLAGPOLE MAX TOP DIAMETER	BALL COLOR ANODIZED FINISH	DESCRIPTION	TOTAL LUMENS	BEACON SIZE	PART NUMBER	1+ SATIN	1+ POWDER COAT
3.5"	Gold	External Halyard BEACON - Standard	500	8" Dia.	ABES-##FS-GLD-***	\$1,720	\$1,811
3.5"	Silver	External Halyard BEACON - Standard	500	8" Dia.	ABES-##FS-SIL-***	\$1,720	\$1,811
Beacon Plus							
3.5"	Gold	External Halyard BEACON PLUS - Standard	572	8" Dia.	ABES-##FP-GLD-***	\$2,238	\$2,329
3.5"	Silver	External Halyard BEACON PLUS - Standard	572	8" Dia.	ABES-##FP-SIL-***	\$2,238	\$2,329



Beacon Plus - Standard External
 Illuminate the flag while at rest!
 The Standard External Halyard Beacon Plus incorporates two vertical 2 Watt MR8 bulbs.

Example Part #: ABES-30FS-GLD-SAT
 American Beacon External Halyard (Standard), 30' Flagpole, 3.5" Max Top Flagpole Diameter, Standard Beacon, Gold Anodized Ball, Satin Finish

= Specify Flagpole Height (20, 25, 30 etc.)
 *** = Specify Finish Option
 (Specified Finishes Applied to Truck Only.)



External Halyard Beacon - Heavy-Duty Rope Halyard - Revolving - Spindle Truck

FLAGPOLE MAX TOP DIAMETER	BALL COLOR ANODIZED FINISH	DESCRIPTION	TOTAL LUMENS	BEACON SIZE	PART NUMBER	1+ SATIN	1+ POWDER COAT
5"	Gold	External Halyard BEACON - Heavy-Duty	500	8" Dia.	ABEH-##5S-GLD-***	\$2,834	\$2,925
5"	Silver	External Halyard BEACON - Heavy-Duty	500	8" Dia.	ABEH-##5S-SIL-***	\$2,834	\$2,925
Beacon Plus							
5"	Gold	External Halyard BEACON PLUS - Heavy-Duty	572	8" Dia.	ABEH-##5P-GLD-***	\$3,351	\$3,442
5"	Silver	External Halyard BEACON PLUS - Heavy-Duty	572	8" Dia.	ABEH-##5P-SIL-***	\$3,351	\$3,442



Beacon Plus - Heavy-Duty External
 Illuminate the flag while at rest!
 The Heavy-Duty External Halyard Beacon Plus incorporates two vertical 2 Watt MR8 bulbs.

Example Part #: ABEH-505P-SIL-BZT
 American Beacon Heavy-Duty External Halyard, 50' Flagpole, 5" Max Top Flagpole Diameter, Beacon Plus, Silver Anodized Ball, BronzeTone Powder Coat Finish

= Specify Flagpole Height (20, 25, 30 etc.)
 *** = Specify Finish Option
 (Specified Finishes Applied to Truck Only.)



Outrigger Stationary Beacon Rope Halyard - Stationary - Cap Style Truck

FLAGPOLE MAX TOP DIAMETER	BALL COLOR ANODIZED FINISH	DESCRIPTION	TOTAL LUMENS	BEACON SIZE	PART NUMBER	1+ SATIN	1+ POWDER COAT
2"	Gold	Outrigger Stationary Beacon	500	8" Dia.	ABOS-202S-GLD-***	\$1,720	\$1,811
2.5"	Gold	Outrigger Stationary Beacon	500	8" Dia.	ABOS-20DS-GLD-***	\$1,720	\$1,811

Example Part #: ABOS-20DS-GLD-SAT
 American Beacon Outrigger Stationary Truck, 20' Flagpole, 2.5" Top Flagpole Diameter, Standard Beacon, Gold Anodized Ball, Satin Finish

Standard wire length on the Outrigger Stationary Beacon is 30'.
 *** = Specify Finish Option
 (Specified Finishes Applied to Truck Only.)



American Beacon – Residential Series

The American Beacon Residential Series offers lighting options for External Halyard flagpoles in both Revolving and Stationary designs. These options provide the most environmentally correct way for flagpole illumination, properly lighting the flag during nighttime hours without lighting adjoining properties and the night sky!

- Revolving Option - External Halyard 359° Revolving Cap Style Truck
- 110 Volt System With Driver Contained Inside the Ball
- Can Be Converted to 12V for Solar Power Options
- Warm White, 3000K LED Light Rated for 25,000+ Hours
- 110V / 120V Input, 12 Volt Output
- Revolving Option - Wire Provided For Flagpole Height Plus 10' (Stationary Option Wire Length is 30')

Patent #7,275,495

*** - Specify Finish Option
 SAT = Satin
 BZT = Bronze Tone Powder Coat
 BLK = Black Powder Coat
 WHT = White Powder Coat

Residential Revolving Beacon Rope Halyard - Revolving - Cap Style Truck

FLAGPOLE TOP DIAMETER	BALL COLOR ANODIZED FINISH	DESCRIPTION	TOTAL LUMENS	BEACON SIZE	PART NUMBER	1+ SATIN	1+ POWDER COAT
1.875"-2"	Gold	Residential Revolving Beacon	250	5" Dia.	ABRR-##2S-GLD-***	\$540	\$631
1.875"-2"	Silver	Residential Revolving Beacon	250	5" Dia.	ABRR-##2S-SIL***	\$540	\$631

= Specify Flagpole Height (20, 25, etc.)
 *** = Specify Finish Option
 (Specified Finishes Applied to Truck Only.)



Residential Stationary Beacon Rope Halyard - Stationary - Cap Style Truck

FLAGPOLE TOP DIAMETER	BALL COLOR ANODIZED FINISH	DESCRIPTION	TOTAL LUMENS	BEACON SIZE	PART NUMBER	1+ SATIN	1+ POWDER COAT
Gold							
1.875"-2"	Gold	Residential Revolving Beacon	250	5" Dia.	ABRS-##2S-GLD-***	\$441	\$532
2.5"	Gold	Residential Revolving Beacon	250	5" Dia.	ABRS-##DS-GLD-***	\$526	\$617
3"	Gold	Residential Revolving Beacon	250	5" Dia.	ABRS-##3S-GLD-***	\$544	\$635
Silver							
1.875"-2"	Silver	Residential Revolving Beacon	250	5" Dia.	ABRS-##2S-SIL***	\$441	\$532
2.5"	Silver	Residential Revolving Beacon	250	5" Dia.	ABRS-##DS-SIL***	\$526	\$617
3"	Silver	Residential Revolving Beacon	250	5" Dia.	ABRS-##3S-SIL***	\$544	\$635

= Specify Flagpole Height (20, 25, etc.)
 *** = Specify Finish Option
 (Specified Finishes Applied to Truck Only.)



Solar Power Package

WATTAGE	PANEL DIMENSIONS	MAXIMUM POWER VOLTAGE	MAXIMUM POWER CURRENT	OPEN CIRCUIT VOLTAGE	PART NUMBER	1+
20W	470mm x 430mm x 17mm	17.3V	1.16A	21.4V	ABSP-2000	\$2,314
30W	360mm x 678mm x 25mm	18.25V	1.64A	21.96V	ABSP-3000	\$2,459
40W	678mm x 500mm x 25mm	18.25V	2.19A	21.96V	ABSP-4000	\$2,846

The American Beacon Solar Power Package includes one Solar Power Collector (20W, 30W, or 40W), one Battery Pack (9Ah, 12Ah, or 15Ah), and one Solar Power Pole Mount. Designed for use with our 12V Solar American Beacon designs (sold separately), this package allows for the proper illumination of the flag without the additional power expense.

Solar Power Collector

- Panel Material – Monocrystalline High Efficiency Photovoltaic
- High Conversion Efficiency
- Low Power Tolerance of 0~+3%
- Low Degradation Under Light Exposure
- Withstands High Wind-Pressure, Snow Loads and Extreme Temperatures
- ISO 9001:2008 (Quality Management System) Certified Factory
- IEC61215, IEC61730, MCS CEC Certified Products
- TUV, CE Conformity



Solar Power Battery

- 3.2V 3000mAh Lithium Iron Phosphate Batteries
- Automatic Cell Balancing
- External on/off switch (Off: For shipping and storage. On: Fully automatic mode)
- Dusk to Dawn Auto-Switching Function
- All units field tested
- Internally fused: 1 Amp

Solar Power Pole Mount

- Used to attach a solar panel to the side of a flagpole
- Ultra-light and strong 5052 Aluminum

American StarGazer -

The **American StarGazer** is a revolutionary Dome Down Lighting series that incorporates the latest LED technology into flagpole lighting. A unique triangulation method of LED placement and the curvature of the dome design create outstanding performance with the most efficient distribution of light. The down lighting design prevents your flagpole lighting from contributing to light pollution created by traditional up lights, allowing the American StarGazer to achieve the International Dark Sky Association's **"Dark Sky Approved"** certification. For use on flag sizes up to 10' x 15', these commercial-grade LED bulbs are rated for 50,000 hours, providing 25 times longer lamp life than halogen lamps (10+ years).

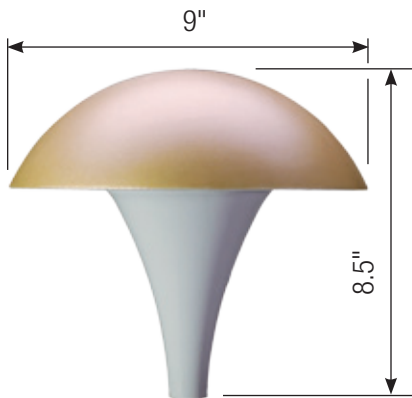

Performance

Input Watts / Amps (LM-79 reported): 5.5 W/0.20 A
 Input Voltage: 24V DC
 Color Accuracy (CRI): 90+
 Temperature Range: -40°F to 149°F
 LED Tape IP Rating: IP67

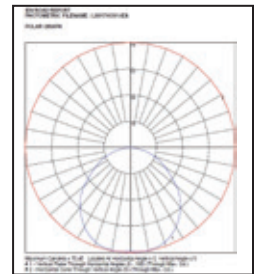
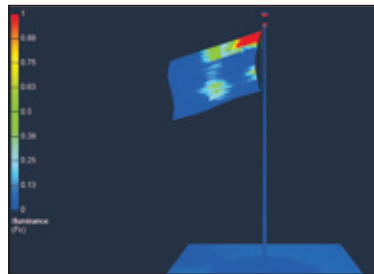

Flagpole Catalog Number Description

Products are identified by the Design, Power Cord Length, Bulb Type, Dome Finish, and Truck Finish.

Catalog Number Example (SGE3-60-3K-GLD-SAT)

DESIGN	CORD LENGTH	BULB TYPE	DOMES FINISH	TRUCK FINISH
SGE3	60	3K	GLD	SAT

SGE3 = External Stationary - 3.5" Top Diameter
 60 = 60' Power Cord
 3K = 3000 Kelvin LED Bulb
 GLD = Gold Dome
 SAT = Satin Truck

Design		Cord Length	
CODE	DESCRIPTION	CODE	LENGTH
SGE3	External Stationary - 3.5"	60	60' (Standard)
SGE4	External Stationary - 4"	00	100'
SGER	External Single Revolving	15	150'
SGED	External Double Revolving		
SGIS	Internal Stationary		
SGIR	Internal Revolving		

Bulb Type		Dome Finish	
CODE	COLOR	CODE	COLOR
3K	3000 Kelvin	GLD	Gold (Standard)
5K	5000 Kelvin	SIL	Silver
AM	Amber	BZT	BronzeTone
		BLK	Black
		WHT	White
		CUS	Specify Color

Truck Finish	
CODE	DESCRIPTION
SAT	Satin
BZT	BronzeTone
BLK	Black
WHT	White
CUS	Specify Color

Contact Customer Service for (CUS) Custom Color Pricing.



American StarGazer - External Rope Halyard Options

Features

- External Halyard Truck, LED dome fixture, and factory installed low voltage power cord shipped as a completely assembled unit.
- Standard LED dome top provided in a Metallic Gold color with clear coat finish. Additional color options are available.
- Truck finish is specified separately from dome top (standard options include SATIN, BRONZETONE, BLACK, and WHITE).
- Downlight designed to accommodate remote mounted low voltage power supply (SOLD SEPARATELY... See Page 89) or is Solar Capable as standard.
- Full cutoff optics.
- LED Array and Wiring Harness are UL Listed.
- Amber and 3000K bulbs are IDA Dark Sky Approved
- Amber bulbs are TURTLE FRIENDLY.
- Energy efficient and long-life LED's rated for 50,000 hours.

***** - Specify Finish Option**
 SAT = Satin
 BZT = BronzeTone Powder Coat
 BLK = Black Powder Coat
 WHT = White Powder Coat

External Rope Halyard - Stationary

FLAGPOLE TOP DIAMETER	DESCRIPTION	BULB TYPE	TOTAL LUMENS	PART NUMBER	1+ SATIN	1+ POWDER COAT
3.5"	Ext. Halyard Stationary Downlight	3000 Kelvin	670	SGE3-##-3K-GLD-***	\$930	\$950
3.5"	Ext. Halyard Stationary Downlight	5000 Kelvin	723	SGE3-##-5K-GLD-***	\$930	\$950
3.5"	Ext. Halyard Stationary Downlight	Amber	658	SGE3-##-AM-GLD-***	\$930	\$950
4"	Ext. Halyard Stationary Downlight	3000 Kelvin	670	SGE4-##-3K-GLD-***	\$970	\$990
4"	Ext. Halyard Stationary Downlight	5000 Kelvin	723	SGE4-##-5K-GLD-***	\$970	\$990
4"	Ext. Halyard Stationary Downlight	Amber	658	SGE4-##-AM-GLD-***	\$970	\$990

Power Supply Sold Separately...See Page 89.

- Specify Cord Length
 60 = 60' (Standard)
 00 = 100' ADD \$90
 15 = 150' ADD \$200
 *** = Specify Finish Option

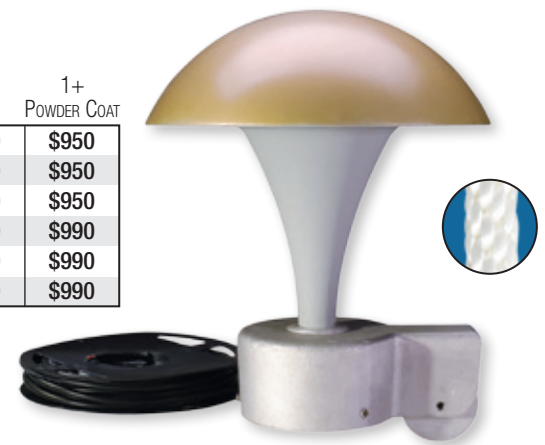

External Rope Halyard - Single Revolving

FLAGPOLE TOP DIAMETER	DESCRIPTION	BULB TYPE	TOTAL LUMENS	PART NUMBER	1+ SATIN	1+ POWDER COAT
4.5"	Ext. Halyard Single Rev. Downlight	3000 Kelvin	670	SGER-##-3K-GLD-***	\$1,225	\$1,265
4.5"	Ext. Halyard Single Rev. Downlight	5000 Kelvin	723	SGER-##-5K-GLD-***	\$1,225	\$1,265
4.5"	Ext. Halyard Single Rev. Downlight	Amber	658	SGER-##-AM-GLD-***	\$1,225	\$1,265

Power Supply Sold Separately...See Page 89.

- Specify Cord Length
 60 = 60' (Standard)
 00 = 100' ADD \$90
 15 = 150' ADD \$200
 *** = Specify Finish Option



External Rope Halyard - Double Revolving

FLAGPOLE TOP DIAMETER	DESCRIPTION	BULB TYPE	TOTAL LUMENS	PART NUMBER	1+ SATIN	1+ POWDER COAT
4.5"	Ext. Halyard Double Rev. Downlight	3000 Kelvin	670	SGED-##-3K-GLD-***	\$1,400	\$1,440
4.5"	Ext. Halyard Double Rev. Downlight	5000 Kelvin	723	SGED-##-5K-GLD-***	\$1,400	\$1,440
4.5"	Ext. Halyard Double Rev. Downlight	Amber	658	SGED-##-AM-GLD-***	\$1,400	\$1,440

Power Supply Sold Separately...See Page 89.

- Specify Cord Length
 60 = 60' (Standard)
 00 = 100' ADD \$90
 15 = 150' ADD \$200
 *** = Specify Finish Option



American StarGazer - Internal Halyard Options

Features

- Internal Halyard Truck, LED dome fixture, and factory installed low voltage power cord shipped as a completely assembled unit.
- Standard LED dome top provided in a Metallic Gold color with clear coat finish. Additional color options are available.
- Truck finish is specified separately from dome top (*standard options include SATIN, BRONZETONE, BLACK, and WHITE*).
- Downlight designed to accommodate remote mounted low voltage power supply (**SOLD SEPARATELY...See Page 89**) or is Solar Capable as standard.
- Full cutoff optics.
- LED Array and Wiring Harness are UL Listed.
- Amber and 3000K bulbs are IDA Dark Sky Approved
- Amber bulbs are TURTLE FRIENDLY.
- Energy efficient and long-life LED's rated for 50,000 hours.

Performance

Input Watts / Amps (LM-79 reported): 5.5 W/0.20 A
 Input Voltage: 24V DC
 Color Accuracy (CRI): 90+
 Temperature Range: -40°F to 149°F
 LED Tape IP Rating: IP67

*** - Specify Finish Option

SAT = Satin
 BZT = BronzeTone Powder Coat
 BLK = Black Powder Coat
 WHT = White Powder Coat



Internal Rope Halyard - Single Stationary

FLAGPOLE TOP DIAMETER	DESCRIPTION	BULB TYPE	TOTAL LUMENS	PART NUMBER	1+ SATIN	1+ POWDER COAT
4.5"	Int. Rope Halyard Stat. Downlight	3000 Kelvin	670	SGIS-##-3K-GLD-***	\$1,120	\$1,160
4.5"	Int. Rope Halyard Stat. Downlight	5000 Kelvin	723	SGIS-##-5K-GLD-***	\$1,120	\$1,160
4.5"	Int. Rope Halyard Stat. Downlight	Amber	658	SGIS-##-AM-GLD-***	\$1,120	\$1,160

Power Supply Sold Separately...See Page 89.

- Specify Cord Length
 60 = 60' (Standard)
 00 = 100' ADD \$90
 15 = 150' ADD \$200
 *** = Specify Finish Option

Internal Rope or Wire Halyard - Single Revolving

FLAGPOLE TOP DIAMETER	DESCRIPTION	BULB TYPE	TOTAL LUMENS	PART NUMBER	1+ SATIN	1+ POWDER COAT
4.5"	Int. Rope Halyard Rev. Downlight	3000 Kelvin	670	SGIR-##-3K-GLD-***	\$1,470	\$1,510
4.5"	Int. Rope Halyard Rev. Downlight	5000 Kelvin	723	SGIR-##-5K-GLD-***	\$1,470	\$1,510
4.5"	Int. Rope Halyard Rev. Downlight	Amber	658	SGIR-##-AM-GLD-***	\$1,470	\$1,510
4.5"	Int. Wire Halyard Rev. Downlight	3000 Kelvin	670	SGIW-##-3K-GLD-***	\$1,470	\$1,510
4.5"	Int. Wire Halyard Rev. Downlight	5000 Kelvin	723	SGIW-##-5K-GLD-***	\$1,470	\$1,510
4.5"	Int. Wire Halyard Rev. Downlight	Amber	658	SGIW-##-AM-GLD-***	\$1,470	\$1,510

Power Supply Sold Separately...See Page 89.

- Specify Cord Length
 60 = 60' (Standard)
 00 = 100' ADD \$90
 15 = 150' ADD \$200
 *** = Specify Finish Option



American In-Ground Series - LED Up Light

The ONLY completely assembled, factory sealed LED In-Ground Flagpole Up Light in the industry provides superior performance with easy installation. Just wire and go!

Recommended Flagpole Height: 35' – 80'
Multiple lights may be needed for your application.

Features & Specifications

Construction:

Compression molded, fiberglass reinforced polyester composite housing. With proper maintenance, will not peel or flake.

Mounting:

This well light is an in-ground fixture and should be installed according to provided installation instructions. A 3/4" conduit entry is supplied into the anti-siphon chamber. All ballast trays are thermally protected and come pre-wired to specific line voltages via quick connects.

- Includes LED Driver, Stainless Steel Ring, Directional Louver & Walk-Over Lens with Etched Slip-Resistant Glass
- Multi-tap 120 - 277VAC
- 25 Watt LED Plate
- 20 Degree Beam Spread
- 4300 lumens / 5000 Kelvin
- CRI: 80
- Lamp hours with photocell (sold separately): 50,000
- Concrete Pour Kit required for concrete installations
- Fixture must be installed by a licensed electrician
- One-year warranty on the fixture and finish.
- 3-year warranty on LED Module

To combat the increasing problem of water build-up inside in-ground fixtures, our in-ground buckets are designed with an anti-siphon chamber. This chamber keeps all ballast components separated from the wiring conduit, which keeps any water absorbed from the ground conned to a separate section.



In-Ground LED Up Light

Dimensions: 9.7" Dia. x 12.8" H
Weight: 16 LBS.
Part No: **IGUL-1000**
Price: **\$1,450**

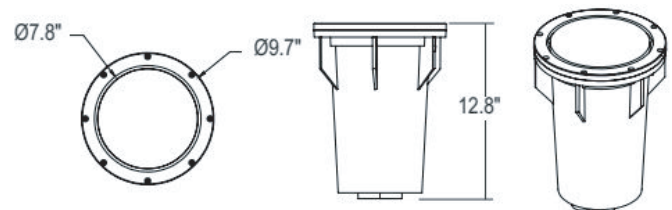

Concrete Pour Kit

Dimensions: 10" Dia. x 6" H
Part No: **CPK-1000**
Price: **\$60**

Required for concrete installations.



Power Supply Line Voltage to Low Voltage For use with ALL American StarGazer Dome Down Lights

- No Load Technology
- Soft Start Feature
- Constant Voltage Output
- ETL Listed For Outdoor Applications
- Overload/Short Circuit/Over-Voltage/Thermal Protection
- Input Voltage: 120-277VAC
- Output Voltage: 24VDC
- Max Watts: 40 Watts
- Power Supply Options Will Power Up To Three (3) Fixtures

Direct Burial

Model #: PS120/277-IG
Dimensions: 9" W x 9" L x 5" H
Weight: 5 LBS.
Part No: **DBP-1000**
Price: **\$360**



NEMA 3R Above Ground

Model #: PS120/277
Dimensions: 2" W x 3.4" L x 9.3" H
Weight: 2.5 LBS.
Part No: **AGP-1000**
Price: **\$245**



Note: Not recommended for mounting on flagpole or in-ground.



Flagpole Windspeed Calculations For Ground Set Installations Based on ANSI/NAAMM FP 1001-07

MTG. HGT.	BUTT DIAMETER	WALL THICKNESS	TOP DIAMETER	OVERALL LENGTH	FLAG SIZE*	EXTERNAL FLAGPOLES <i>Estate ESS · Continental ESR · Xtreme XESR</i>				INTERNAL - WINCH - REINFORCED <i>Sovereignty ISW · Independence IRW · Xtreme XIW</i>				INTERNAL - WINCH - HINGED DOOR <i>Titan IWW · Xtreme XIWW</i>				
						No FLAG	SINGLE NYLON FLAG	SINGLE POLYESTER FLAG	DOUBLE NYLON FLAGS**	No FLAG	SINGLE NYLON FLAG	SINGLE POLYESTER FLAG	DOUBLE NYLON FLAGS**	No FLAG	SINGLE NYLON FLAG	SINGLE POLYESTER FLAG	DOUBLE NYLON FLAGS**	
15'	3"	.125"	2"	17'	3' x 5'	149	113	103	102	-	-	-	-	-	-	-	-	
					2' x 3'	149	122	113	108	-	-	-	-	-	-	-		
	20'	3"	.125"	2"	22'	4' x 6'	108	83	76	74	-	-	-	-	-	-	-	
						3' x 5'	108	86	80	79	-	-	-	-	-	-	-	
		4"	.125"	2"	22'	4' x 6'	147	109	97	98	-	-	-	-	-	-	-	
						3' x 5'	147	113	101	104	-	-	-	-	-	-	-	
		5"	.125"	3"	22'	4' x 6'	229	136	123	119	-	-	-	-	-	-	-	
						3' x 5'	229	144	131	128	-	-	-	-	-	-	-	
		5"	.156"	3"	22'	4' x 6'	262	160	142	136	262	160	142	136	-	-	-	-
						3' x 5'	262	171	152	148	262	171	152	148	-	-	-	-
5"		.188"	3"	22'	4' x 6'	287	182	160	153	287	182	160	153	-	-	-	-	
					3' x 5'	287	195	173	168	287	195	173	168	-	-	-	-	
6"	.156"	3.5"	22'	4' x 6'	301	208	187	178	301	208	187	178	256	152	135	129		
				3' x 5'	301	220	198	195	301	220	198	195	256	163	145	141		
6"	.188"	3.5"	22'	4' x 6'	328	229	205	198	328	229	205	198	280	174	153	147		
				3' x 5'	328	242	218	215	328	242	218	215	280	186	165	161		
25'	3"	.125"	2"	26.5'	5' x 8'	83	63	58	56	-	-	-	-	-	-	-		
					4' x 6'	83	66	61	59	-	-	-	-	-	-	-		
	4"	.125"	2"	26.5'	5' x 8'	106	83	75	75	-	-	-	-	-	-	-		
					4' x 6'	106	87	78	78	-	-	-	-	-	-	-		
	5"	.125"	3"	26.5'	5' x 8'	136	98	90	89	-	-	-	-	-	-	-		
					4' x 6'	136	102	94	92	-	-	-	-	-	-	-		
	5"	.156"	3"	26.5'	5' x 8'	178	111	99	99	178	111	99	99	-	-	-	-	
					4' x 6'	178	117	106	104	178	117	106	104	-	-	-	-	
	5"	.188"	3"	26.5'	5' x 8'	209	124	112	109	209	124	112	109	-	-	-	-	
					4' x 6'	209	132	119	116	209	132	119	116	-	-	-	-	
	5.5"	.188"	3.5"	26.5'	5' x 8'	231	146	130	124	-	-	-	-	-	-	-		
					4' x 6'	231	158	142	133	-	-	-	-	-	-	-		
	6"	.156"	3.5"	26.5'	5' x 8'	230	149	132	126	230	149	132	126	162	100	92	90	
					4' x 6'	230	160	143	135	230	160	143	135	162	105	97	94	
	6"	.188"	3.5"	26.5'	5' x 8'	253	168	150	143	253	168	150	143	192	112	102	99	
					4' x 6'	253	180	162	154	253	180	162	154	192	119	109	105	
	6"	.250"	3.5"	26.5'	5' x 8'	287	197	177	169	287	197	177	169	231	137	122	118	
					4' x 6'	287	210	190	181	287	210	190	181	231	148	132	126	
7"	.250"	3.5"	26.5'	5' x 8'	-	-	-	-	-	-	-	-	294	190	170	163		
				4' x 6'	-	-	-	-	-	-	-	294	204	184	175			
30'	4"	.125"	2"	33'	6' x 10'	85	66	59	58	-	-	-	-	-	-	-		
					5' x 8'	85	68	61	60	-	-	-	-	-	-	-		
	5"	.125"	3"	33'	6' x 10'	96	78	71	71	-	-	-	-	-	-	-		
					5' x 8'	96	80	75	74	-	-	-	-	-	-	-		
	5"	.156"	3"	33'	6' x 10'	112	86	80	78	112	86	80	78	-	-	-		
					5' x 8'	112	89	83	81	112	89	83	81	-	-	-		
	5"	.188"	3"	33'	6' x 10'	131	94	86	85	131	94	86	85	-	-	-		
					5' x 8'	131	97	90	89	131	97	90	89	-	-	-		
	6"	.156"	3.5"	33'	6' x 10'	174	108	98	95	174	108	98	95	98	75	71	69	
					5' x 8'	174	113	102	100	174	113	102	100	98	77	73	71	
6"	.188"	3.5"	33'	6' x 10'	197	122	110	106	197	122	110	106	114	83	77	75		
				5' x 8'	197	129	116	112	197	129	116	112	114	86	80	78		
6"	.250"	3.5"	33'	6' x 10'	229	150	132	126	229	150	132	126	159	98	90	87		
				5' x 8'	229	159	142	135	229	159	142	135	159	102	94	91		
7"	.188"	3.5"	33'	6' x 10'	235	157	140	134	235	157	140	134	188	113	103	99		
				5' x 8'	235	165	150	143	235	165	150	143	188	119	108	104		
8"	.250"	3.5"	33'	6' x 10'	-	-	-	-	-	-	-	-	269	178	160	152		
				5' x 8'	-	-	-	-	-	-	-	269	188	170	162			
35'	5"	.125"	3"	38.5'	6' x 10'	78	66	60	60	-	-	-	-	-	-	-		
					5' x 8'	78	67	63	62	-	-	-	-	-	-	-		
	5"	.156"	3"	38.5'	6' x 10'	87	73	68	66	87	73	68	66	-	-	-		
					5' x 8'	87	75	70	69	87	75	70	69	-	-	-		
	5"	.188"	3"	38.5'	6' x 10'	95	79	73	72	95	79	73	72	-	-	-		
					5' x 8'	95	81	75	75	95	81	75	75	-	-	-		
	6"	.156"	3.5"	38.5'	6' x 10'	116	87	79	78	116	87	79	78	-	-	-		
					5' x 8'	116	90	81	81	116	90	81	81	-	-	-		
	6"	.188"	3.5"	38.5'	6' x 10'	145	97	90	87	145	97	90	87	-	-	-		
					5' x 8'	145	101	92	91	145	101	92	91	-	-	-		
	7"	.156"	3.5"	38.5'	6' x 10'	165	110	101	97	165	110	101	97	106	80	75	73	
					5' x 8'	165	116	106	102	165	116	106	102	106	83	78	76	
7"	.188"	3.5"	38.5'	6' x 10'	187	127	114	109	187	127	114	109	127	90	84	81		
				5' x 8'	187	134	121	115	187	134	121	115	127	93	87	84		
7"	.250"	3.5"	38.5'	6' x 10'	219	153	138	131	-	-	-	-	-	-	-			
				5' x 8'	219	161	140	140	-	-	-	-	-	-	-			



Call Concord American Flagpole for Wind Speed information on Shoe Base, Wall Mount, Rooftop and Nautical Flagpole Installations and for Flag Size applications NOT listed.

*NAAMM recommended maximum flag sizes are shaded.

**Double Flags calculated on NANMM recommended maximum size and one size down (i.e. 5' x 8' and 4' x 6' for 25' flagpoles). Exception: 2' x 3' use the same size for both flags.

Flagpole Windspeed Calculations For Ground Set Installations Based on ANSI/NAAMM FP 1001-07

MTG. HGT.	BUTT DIAMETER	WALL THICKNESS	TOP DIAMETER	OVERALL LENGTH	FLAG SIZE*	EXTERNAL FLAGPOLES Estate ESS - Continental ESR - Xtreme XESR				INTERNAL - WINCH - REINFORCED Sovereignty ISW - Independence IRW - Xtreme XIRW				INTERNAL - WINCH - HINGED DOOR Titan IWV - Xtreme XIWV			
						No FLAG	SINGLE NYLON FLAG	SINGLE POLYESTER FLAG	DOUBLE NYLON FLAGS**	No FLAG	SINGLE NYLON FLAG	SINGLE POLYESTER FLAG	DOUBLE NYLON FLAGS**	No FLAG	SINGLE NYLON FLAG	SINGLE POLYESTER FLAG	DOUBLE NYLON FLAGS**
35'	8"	.188"	4"	38.5'	6' x 10'	-	-	-	-	213	155	140	134	179	119	107	102
	8"	.188"	4"	38.5'	5' x 8'	-	-	-	-	213	162	148	142	179	125	113	108
	8"	.250"	4"	38.5'	6' x 10'	249	181	164	157	249	181	164	157	212	144	130	123
	8"	.250"	4"	38.5'	5' x 8'	249	189	172	166	249	189	172	166	212	151	137	131
	8"	.312"	3.5"	38.5'	6' x 10'	-	-	-	-	-	-	-	-	237	164	148	141
	8"	.312"	3.5"	38.5'	5' x 8'	-	-	-	-	-	-	-	-	237	173	157	150
40'	7"	.156"	3.5"	44'	8' x 12'	122	87	79	78	122	87	79	78	80	65	61	60
	7"	.156"	3.5"	44'	6' x 10'	122	90	82	81	122	90	82	81	80	66	63	61
	8"	.156"	4"	44'	8' x 12'	157	107	96	93	157	107	96	93	112	80	74	72
	8"	.156"	4"	44'	6' x 10'	157	113	102	98	157	113	102	98	112	83	78	75
	8"	.188"	4"	44'	8' x 12'	177	123	110	106	177	123	110	106	136	90	83	80
	8"	.188"	4"	44'	6' x 10'	177	129	118	112	177	129	118	112	136	94	87	84
	8"	.250"	4"	44'	8' x 12'	205	146	132	127	205	146	132	127	167	110	100	96
	8"	.250"	4"	44'	6' x 10'	205	154	141	134	205	154	141	134	167	117	106	101
	8"	.312"	3.5"	44'	8' x 12'	231	165	150	144	-	-	-	-	-	-	-	-
	8"	.312"	3.5"	44'	6' x 10'	231	174	159	151	-	-	-	-	-	-	-	-
	10"	.188"	4"	44'	8' x 12'	-	-	-	-	226	166	148	145	204	141	127	122
	10"	.188"	4"	44'	6' x 10'	-	-	-	-	226	174	156	152	204	149	135	129
	10"	.250"	4"	44'	8' x 12'	-	-	-	-	259	192	171	169	234	166	151	145
	10"	.250"	4"	44'	6' x 10'	-	-	-	-	259	201	179	177	234	175	160	152
45'	8"	.188"	4"	49.5'	8' x 12'	144	102	92	89	144	102	92	89	100	76	70	68
	8"	.188"	4"	49.5'	6' x 10'	144	107	97	94	144	107	97	94	100	79	73	71
	8"	.250"	4"	49.5'	8' x 12'	-	-	-	-	173	125	115	108	-	-	-	-
	8"	.250"	4"	49.5'	6' x 10'	-	-	-	-	173	131	122	114	-	-	-	-
	10"	.188"	4"	49.5'	8' x 12'	-	-	-	-	192	143	130	125	167	118	107	102
	10"	.188"	4"	49.5'	6' x 10'	-	-	-	-	192	150	137	132	167	124	114	108
	10"	.219"	4"	49.5'	8' x 12'	-	-	-	-	208	156	141	137	-	-	-	-
	10"	.219"	4"	49.5'	6' x 10'	-	-	-	-	208	163	148	144	-	-	-	-
	10"	.250"	3.5"	49.5'	8' x 12'	-	-	153	-	-	-	153	-	-	-	-	-
	10"	.250"	3.5"	49.5'	6' x 10'	226	168	159	155	226	168	159	155	-	-	-	-
50'	8"	.188"	3.5"	55'	10' x 15'	117	83	75	74	117	83	75	74	-	-	-	-
	8"	.188"	3.5"	55'	8' x 12'	117	86	79	77	117	86	79	77	-	-	-	-
	10"	.188"	4"	55'	10' x 15'	164	118	107	103	164	118	107	103	136	94	87	84
	10"	.188"	4"	55'	8' x 12'	164	123	113	109	164	123	113	109	136	99	91	88
	10"	.250"	4"	55'	10' x 15'	191	140	126	123	191	140	126	123	165	115	104	100
	10"	.250"	4"	55'	8' x 12'	191	147	132	130	191	147	132	130	165	121	110	106
	10"	.312"	4"	55'	10' x 15'	213	158	143	139	213	158	143	139	186	132	120	115
	10"	.312"	4"	55'	8' x 12'	213	165	150	147	213	165	150	147	186	139	127	121
	12"	.250"	4"	55'	10' x 15'	242	179	156	157	242	179	156	157	222	158	143	138
	12"	.250"	4"	55'	8' x 12'	242	187	163	166	242	187	163	166	222	166	152	145
	12"	.250"	4"	55'	10' x 15'	-	-	-	-	-	-	-	-	246	178	162	156
	12"	.250"	4"	55'	8' x 12'	-	-	-	-	-	-	-	-	246	187	172	164
55'	10"	.188"	4"	60.5'	10' x 15'	139	102	94	90	139	102	94	90	-	-	-	-
	10"	.188"	4"	60.5'	8' x 12'	139	107	99	95	139	107	99	95	-	-	-	-
60'	10"	.188"	4"	66'	12' x 18'	118	86	78	76	118	86	78	76	89	68	63	61
	10"	.188"	4"	66'	10' x 15'	118	89	81	79	118	89	81	79	89	70	66	64
	10"	.250"	4"	66'	12' x 18'	143	104	95	91	143	104	95	91	113	82	76	73
	10"	.250"	4"	66'	10' x 15'	143	108	99	96	143	108	99	96	113	85	79	76
	10"	.312"	4"	66'	12' x 18'	-	-	-	-	162	119	110	104	-	-	-	-
	10"	.312"	4"	66'	10' x 15'	-	-	-	-	162	124	115	109	-	-	-	-
	12"	.250"	4"	66'	12' x 18'	187	137	122	120	187	137	123	120	166	117	106	101
	12"	.250"	4"	66'	10' x 15'	187	142	128	126	187	142	128	126	166	121	111	107
	12"	.312"	4"	66'	12' x 18'	209	155	138	136	209	155	138	136	-	-	-	-
	12"	.312"	4"	66'	10' x 15'	209	161	143	142	209	161	143	142	-	-	-	-
	12"	.375"	4"	66'	12' x 18'	228	171	151	150	228	171	151	150	205	149	136	130
	12"	.375"	4"	66'	10' x 15'	228	177	157	157	228	177	157	157	205	155	142	137
65'	10"	.312"	4"	71.5'	12' x 18'	142	106	97	93	142	106	97	93	-	-	-	-
	10"	.312"	4"	71.5'	10' x 15'	142	109	100	97	142	109	100	97	-	-	-	-
	12"	.250"	4"	71.5'	12' x 18'	165	122	111	105	165	122	111	105	-	-	-	-
	12"	.250"	4"	71.5'	10' x 15'	165	127	115	109	165	127	115	109	-	-	-	-
70'	10"	.312"	4"	77'	12' x 18'	123	94	85	82	123	94	85	82	94	72	67	65
	10"	.312"	4"	77'	10' x 15'	123	97	89	86	123	97	89	86	94	74	70	68
	12"	.250"	4"	77'	12' x 18'	145	109	100	96	145	109	100	96	122	90	84	81
	12"	.250"	4"	77'	10' x 15'	145	113	103	101	145	113	103	101	122	94	87	85
	12"	.375"	4"	77'	12' x 18'	181	139	126	123	181	139	126	123	-	-	-	-
12"	.375"	4"	77'	10' x 15'	181	144	130	128	181	144	130	128	-	-	-	-	
75'	12"	.375"	4"	82.5'	12' x 18'	161	126	115	111	161	126	115	111	-	-	-	-
	12"	.375"	4"	82.5'	10' x 15'	161	130	119	116	161	130	119	116	-	-	-	-
80'	12"	.375"	4"	88'	15' x 25'	144	107	99	95	144	107	99	95	121	89	82	80
	12"	.375"	4"	88'	12' x 18'	144	113	105	103	144	113	105	103	121	94	87	84

Call Concord American Flagpole for Wind Speed information on Shoe Base, Wall Mount, Rooftop and Nautical Flagpole Installations and for Flag Size applications NOT listed.

*NAAMM recommended maximum flag sizes are shaded.

**Double Flags calculated on NANMM recommended maximum size and one size down (i.e. 5' x 8' and 4' x 6' for 25' flagpoles). Exception: 2' x 3' use the same size for both flags.



Flagpole Windspeed Calculations For Ground Set Installations

Based on ANSI/NAAMM FP 1001-07

MTG. HGT.	BUTT DIAMETER	WALL THICKNESS	TOP DIAMETER	OVERALL LENGTH	FLAG SIZE*	INTERNAL - CAM CLEAT - REINFORCED Sentry ISC - Sentry II IRC				INTERNAL - CAM CLEAT - HINGED DOOR Monarch ICC			
						No FLAG	SINGLE NYLON FLAG	SINGLE POLYESTER FLAG	DOUBLE NYLON FLAGS**	No FLAG	SINGLE NYLON FLAG	SINGLE POLYESTER FLAG	DOUBLE NYLON FLAGS**
20'	5"	.125"	3"	22'	4' x 6'	229	136	123	119	204	117	108	105
	5"	.125"	3"	22'	3' x 5'	229	144	131	128	204	123	113	111
	5"	.156"	3"	22'	4' x 6'	262	160	142	136	244	134	121	118
	5"	.156"	3"	22'	3' x 5'	262	171	152	148	244	142	129	126
	5"	.188"	3"	22'	4' x 6'	287	182	160	153	272	151	135	130
	5"	.188"	3"	22'	3' x 5'	287	195	173	168	272	162	144	141
	6"	.156"	3.5"	22'	4' x 6'	301	208	187	178	301	194	171	164
	6"	.156"	3.5"	22'	3' x 5'	301	220	198	195	301	206	185	180
25'	5"	.125"	3"	26.5'	4' x 6'	229	136	123	119	204	117	108	105
	5"	.125"	3"	26.5'	5' x 8'	136	98	90	89	110	84	78	76
	5"	.156"	3"	26.5'	4' x 6'	136	102	94	92	110	87	82	79
	5"	.156"	3"	26.5'	5' x 8'	178	111	99	99	129	93	87	84
	5"	.188"	3"	26.5'	4' x 6'	178	117	106	104	129	97	91	88
	5"	.188"	3"	26.5'	5' x 8'	209	124	112	109	157	102	94	92
	5"	.188"	3"	26.5'	4' x 6'	209	132	119	116	157	107	100	96
	5.5"	.188"	3.5"	26.5'	5' x 8'	231	146	130	124	209	120	109	105
	5.5"	.188"	3.5"	26.5'	4' x 6'	231	158	142	133	209	128	116	111
	6"	.156"	3.5"	26.5'	5' x 8'	230	149	132	126	216	126	114	110
	6"	.156"	3.5"	26.5'	4' x 6'	230	160	143	135	216	136	122	117
	6"	.188"	3.5"	26.5'	5' x 8'	253	168	150	143	240	144	128	123
30'	5"	.125"	3"	33'	6' x 10'	96	78	71	71	-	-	-	-
	5"	.125"	3"	33'	5' x 8'	96	80	75	74	-	-	-	-
	5"	.156"	3"	33'	6' x 10'	112	86	80	78	90	72	67	65
	5"	.156"	3"	33'	5' x 8'	112	89	83	81	90	74	70	68
	5"	.188"	3"	33'	6' x 10'	131	94	86	85	-	-	-	-
	5"	.188"	3"	33'	5' x 8'	131	97	90	89	-	-	-	-
	6"	.156"	3.5"	33'	6' x 10'	174	108	98	95	138	91	85	82
	6"	.156"	3.5"	33'	5' x 8'	174	113	102	100	138	95	88	86
	6"	.188"	3.5"	33'	6' x 10'	197	122	110	106	170	102	94	91
	6"	.188"	3.5"	33'	5' x 8'	197	129	116	112	170	107	98	95
	6"	.250"	3.5"	33'	6' x 10'	229	150	132	126	-	-	-	-
	6"	.250"	3.5"	33'	5' x 8'	229	159	142	135	-	-	-	-
35'	5"	.125"	3"	38.5'	6' x 10'	78	66	60	60	-	-	-	-
	5"	.125"	3"	38.5'	5' x 8'	78	67	63	62	-	-	-	-
	5"	.156"	3"	38.5'	6' x 10'	87	73	68	66	-	-	-	-
	5"	.156"	3"	38.5'	5' x 8'	87	75	70	69	-	-	-	-
	5"	.188"	3"	38.5'	6' x 10'	95	79	73	72	-	-	-	-
	5"	.188"	3"	38.5'	5' x 8'	95	81	75	75	-	-	-	-
	6"	.156"	3.5"	38.5'	6' x 10'	116	87	79	78	93	74	70	68
	6"	.156"	3.5"	38.5'	5' x 8'	116	90	81	81	93	76	72	70
	6"	.188"	3.5"	38.5'	6' x 10'	145	97	90	87	107	81	76	74
	6"	.188"	3.5"	38.5'	5' x 8'	145	101	92	91	107	84	79	77
	7"	.156"	3.5"	38.5'	6' x 10'	165	110	101	97	142	95	88	85
	7"	.156"	3.5"	38.5'	5' x 8'	165	116	106	102	142	99	92	89
40'	7"	.188"	3.5"	38.5'	6' x 10'	187	127	114	109	167	107	99	95
	7"	.188"	3.5"	38.5'	5' x 8'	187	134	121	115	167	112	103	99
	8"	.188"	4"	38.5'	6' x 10'	213	155	140	134	-	-	-	-
	8"	.188"	4"	38.5'	5' x 8'	213	162	148	142	-	-	-	-
	8"	.250"	4"	38.5'	6' x 10'	244	181	164	157	-	-	-	-
	8"	.250"	4"	38.5'	5' x 8'	244	189	172	167	-	-	-	-
	7"	.156"	3.5"	44'	8' x 12'	122	87	79	78	99	75	70	68
	7"	.156"	3.5"	44'	6' x 10'	122	90	82	81	99	78	73	71
	8"	.156"	4"	44'	8' x 12'	157	107	96	93	141	93	85	83
	8"	.156"	4"	44'	6' x 10'	157	113	102	98	141	97	90	86
	8"	.188"	4"	44'	8' x 12'	177	123	110	106	162	106	96	93
	8"	.188"	4"	44'	6' x 10'	177	129	118	112	162	112	102	97
8"	.250"	4"	44'	8' x 12'	205	146	132	127	-	-	-	-	
8"	.250"	4"	44'	6' x 10'	205	154	141	134	-	-	-	-	

Call Concord American Flagpole for Wind Speed information on Shoe Base, Wall Mount, Rooftop and Nautical Flagpole Installations and for Flag Size applications NOT listed.

*NAAMM recommended maximum flag sizes are shaded.

**Double Flags calculated on NANMM recommended maximum size and one size down (i.e. 5' x 8' and 4' x 6' for 25' flagpoles).
Exception: 2' x 3' use the same size for both flags.



Terms and Conditions of Sale

Conditions

All orders or contracts are accepted with the understanding that they are subject to **Concord American Flagpole's (CAFP)** ability to obtain the necessary raw materials, and all orders or contracts as well as shipments applicable thereto are subject to CAFP's current manufacturing schedules, and government regulations, orders, directives and restrictions that may be in effect from time to time.

Quotations

Written quotations automatically expire thirty (30) calendar days from the date issued unless otherwise stated on the face of the quotation. Quotations are subject to termination by notice within that period. Quotations are subject to correction in the event of stenographic or clerical errors. Prices quoted are for specific quantities shown, released for manufacture and shipment at one time to one destination unless otherwise stated. Any change in the quantity of an order and/or split shipments are subject to price revision.

Prices

Prices shown in this price list are Recommended List Prices and do not include freight or installation costs. Dealer discounts are applicable. Prices are FOB shipping facility. CAFP will pay the freight and add a freight charge to the invoice. Upon request, motor freight shipments can be shipped collect or as a prepaid in the name of the invoice bill-to. Purchases are invoiced at the time of shipment. Applications for an open account should be submitted in advance of placing the first order. Credit card orders are accepted.

To qualify for listed Quantity discounts, the following guidelines are in effect:

- Quantities of similar items within a product group of similar groups may be mixed to achieve the discounted pricing.
- The order should be a single order shipping to a single destination. Contact Customer Service for blanket or multiple release orders.

Prices are subject to change without notice and orders calling for future shipment will be billed according to the price in effect at the time of shipment, unless otherwise specified.

Taxes

Prices on the specified products are exclusive of all city, state and federal excise taxes, including without limitation, taxes on manufacture, sales, receipts, gross income, occupation, use and similar taxes. Wherever applicable, any tax or taxes will be added to the invoice as a separate charge to be paid by the Buyer.

Shipment

All prices are F.O.B. factory of origination (TX, VA, or MN), unless otherwise stated. Method and route of shipment are at CAFP's discretion, unless the Buyer supplies explicit shipping instructions. When Buyer specifies method of shipment, any additional shipping expense will be charged to Buyer. Shipping charges are not intended to guarantee the delivery at or to destination. Identification of goods to the contract shall occur as each shipment is placed in the hands of the carrier.

Deliveries

Deliveries shall be subject to, and contingent upon, strikes, labor difficulties, civil unrest, war, fire, delay or defaults of common carriers, failure or curtailment in CAFP's usual sources of supply, governmental decrees or orders, or without limiting the foregoing, any other delays beyond CAFP's reasonable control, and CAFP shall not be liable for any loss or damage arising therefrom. CAFP shall have the additional right, in the event of the happening of any of the above contingencies, at its option, to cancel this contract or any part thereof, without any resulting liability. Shipments made within twenty (20) days after specified date of delivery shall constitute a good delivery. Any delivery not in dispute shall be paid for regardless of other controversies relating to other delivered or undelivered merchandise.

If merchandise is delivered showing signs of freight damage, refuse the shipment and contact Customer Service within three (3) business days. We will promptly reship your order and file a freight claim for the damages. If a visually damaged shipment is accepted and the damage later claimed, the responsibility for filing the claim may be that of the customer.

Packaging

Unless otherwise stated on the face of the quotation, all packaging will be in accordance with CAFP's standard practices for domestic shipments. Cartons of parts are carefully packed. CAFP will not be responsible for any shortages if they are not reported within 30 days of receipt.

NOTE: Satin aluminum flagpole shafts can stain if allowed to remain in contact with wet or damp wrappings. If there is any sign of moisture, immediately remove the shaft from the tube, unwrap, and dry immediately. If the shaft is to be stored outdoors, it must be stored off the ground and unwrapped.

Limited Lifetime Warranty For Flagpoles

Concord American Flagpole ("CAFP") warrants to the first purchaser ("**Buyer**") of a CAFP flagpole shaft (*the "Flagpole"*) that the Flagpole will, upon shipment by CAFP, be free from defects in material and workmanship and to be free from corrosion except those items normally consumed in service (*the "Warranty"*). The Warranty applies to the pole shaft only and excludes anchor bolts, flagpole accessories, foundations and finishes such as powder coating and anodizing. CAFP provides separate warranties for its anodized and powder coated finishes and for hardware and other Flagpole accessories. **WITH RESPECT TO FLAGS, CAFP MAKES NO, AND EXPRESSLY DISCLAIMS, ALL WARRANTIES.**

If any failure to conform to the Warranty appears, and written notice of such failure is given to CAFP during the lifetime of the Flagpole's intended use (*the "Warranty Period"*), CAFP will, upon substantiation of such nonconformity and at its sole option, either repair or replace the non-conforming Flagpole. Specifically excluded from the Warranty is the cost to remove, ship, replace, or reinstall the non-conforming or repaired/replaced Flagpole. Repair or replacement by CAFP is the Buyer's sole remedy, and CAFP's sole obligation, in the event of a failure to conform to the Warranty. The Warranty does not cover defects or failures resulting from improper maintenance, misuse, abuse, radiation, overloading, accident, acts of God, or other casualty beyond the control of CAFP, alterations, modification or additions without written permission from CAFP, or from failures or corrosion due to:

(continued on page 94)



(continued from page 93)

- Improper installation.
- Misapplication – product used outside of specified use.
- Damage from handling, transportation, installation, vehicular impact, abuse, or vandalism.
- Site specific wind induced or other vibration.
- Installation in soils with a pH under 5 or over 9.
- Installation using highly caustic grouts or concrete.
- Improper grounding.

All warranty claims must be directed to:

CONCORD AMERICAN FLAGPOLE,
Customer Service Department, P.O. BOX 2449,
Addison, Texas 75001. The Flagpole shall not
be returned without prior written authorization
of CAFP and must be shipped freight prepaid
by the Buyer. If CAFP elects to replace the
nonconforming Flagpole, such replaced Flagpole
shall become the property of CAFP.

CAFP MAKES NO OTHER EXPRESS WARRANTY
AND EXPRESSLY DISCLAIMS ANY WARRANTY
OF MERCHANTABILITY OR FITNESS FOR
A PARTICULAR PURPOSE AND ALL OTHER
IMPLIED WARRANTIES OTHER THAN THOSE
THAT MAY NOT BE DISCLAIMED AS A MATTER
OF LAW. THE DURATION OF ANY IMPLIED
WARRANTY THAT MAY NOT BE DISCLAIMED
BY APPLICABLE STATE OR FEDERAL LAW IS
LIMITED TO THE WARRANTY PERIOD.

Regardless of whether a claim against CAFP
is based on the Warranty or is an action in
contract, tort (*negligence or strict liability*) or
otherwise, CAFP's liability for losses, damages,
or expenses of any kind arising from the design,
manufacture, installation, use, repair, or sale
of the flagpole is limited, unless otherwise
prohibited by applicable law, to an amount
not exceeding the cost of the CAFP flagpole
giving rise to such liability. CAFP shall not be
liable or responsible for any indirect, incidental,
consequential or special damages.

Some states do not allow limitations on how
long an implied warranty lasts or the exclusion
or limitation of incidental or consequential
damages, so the above limitations and exclusion
may not apply to you. This warranty gives you
specific legal rights and you may also have
other rights which may vary from state to state.

Limited One-Year Warranty For Flagpole Accessories

Concord American Flagpole ("CAFP") warrants
to the first purchaser ("Buyer") of a CAFP
aluminum flagpole that the accessories other
than flags (*the "Accessories"*) accompanying
the flagpole or sold as replacement component
parts will, upon shipment by CAFP, be free from
defects in material and workmanship
(*the "Warranty"*).

If any failure to conform to the Warranty appears
and written notice of such failure is given to
CAFP within one (1) year from the date of
shipment by CAFP (*the "Warranty Period"*),
CAFP will, upon substantiation of such failure
and at its sole option, either repair or replace
the non-conforming Accessory. Specifically
excluded from the Warranty is the cost to
remove, ship, or reinstall the flagpole or the
Accessory. Repair or replacement by CAFP
is the Buyer's sole remedy, and CAFP's sole
obligation, in the event of a failure to conform
to the Warranty. The Warranty does not cover
defects or failures resulting from improper
installation or maintenance, misuse, abuse,
radiation, overloading, accident, acts of God,
alterations, modification or additions without
written permission from CAFP, or any other
occurrences beyond the control of CAFP.

Limited One-Year Warranty For Anodized Finish

Concord American Flagpole ("CAFP") warrants
to the first purchaser ("Buyer") of a CAFP
aluminum flagpole that the anodized finish
(*the "Finish"*) on the flagpole will, upon shipment
by CAFP, be free from defects in material and
workmanship (*the "Warranty"*).

If the Finish exhibits any excessive fading
due to normal climatic exposure, and written
notice of such failure is given to CAFP within
one (1) year from the date of shipment by
CAFP (*the "Warranty Period"*), CAFP will, upon
substantiation of such failure and at its sole
option, either repair or replace the Finish.
Anodizing is an electro-chemical process
resulting in a colored aluminum oxide layer
on the flagpole surface. Color variation will
inherently occur between the tube
(*Alloy 6063-T6*), castings (*Alloy 356*) and
weld metal (*Alloy 4043*). Minute differences
in the surface properties of the tube caused
by fabrication processes such as tapering can
also result in slight color variation of anodized
finishes. These variations are more pronounced
in light and medium color anodizing. These color
variations in anodized finishes are not defects or
failures and are not covered by the Warranty.

Specifically excluded from the Warranty is the
cost to remove, ship, or reinstall the flagpole
with the Finish. Repair or replacement by CAFP
is the Buyer's sole remedy, and CAFP's sole
obligation, in the event of a failure to conform
to the Warranty. The Warranty does not cover
defects or failures resulting from improper
installation or maintenance, misuse, abuse,
radiation, overloading, use of caustic cleaning
agents, accident, acts of God or other casualty
beyond the control of CAFP.

Limited One-Year Warranty For Powder Coated Finish

Concord American Flagpole ("CAFP")
warrants to the first purchaser ("Buyer") of
a CAFP aluminum flagpole that the factory-
applied powder coating (*the "Coating"*) on the
flagpole will, upon shipment by CAFP, be free
from defects in material and workmanship
(*the "Warranty"*).

If the Coating exhibits any cracking, peeling or
excessive fading, and written notice of such
failure is given to CAFP within one (1) year from
the date of shipment by CAFP (*the "Warranty
Period"*), CAFP will, upon substantiation of such
failure and at its sole option, either repair or
replace the Coating. Specifically excluded from
the Warranty is the cost to remove, ship, or
reinstall the flagpole with the Coating. Repair
or replacement by CAFP is the Buyer's sole
remedy, and CAFP's sole obligation, in the
event of a failure to conform to the Warranty.
The Warranty does not cover defects or
failures resulting from improper installation
or maintenance, misuse, abuse, radiation,
overloading, use of caustic cleaning agents,
accident, acts of God or other casualty beyond
the control of CAFP.

Limitations of Warranties

Flagpole shafts and Accessory cartons should
be inspected upon delivery. Products are
carefully packaged and while visible damage
does not guarantee automatic flagpole or
accessory damage, it is a reason to inspect
more closely. Note any sign of damage or
shortage on the freight bill when signing for the
product. Warranties do not cover failure to notify
common carriers of apparent or concealed
damages when receiving merchandise or
staining on Satin finish flagpoles due to failure
to remove product from wet or damp wrappings.

(continued on page 95)



Limitations of Remedy

CAFP MAKES NO OTHER EXPRESS WARRANTY AND EXPRESSLY DISCLAIMS ANY WARRANTY OF MERCHANTABILITY OR FITNESS FOR A PARTICULAR PURPOSE AND ALL OTHER IMPLIED WARRANTIES OTHER THAN THOSE THAT MAY NOT BE DISCLAIMED AS A MATTER OF LAW. THE DURATION OF ANY IMPLIED WARRANTY THAT MAY NOT BE DISCLAIMED BY APPLICABLE STATE OR FEDERAL LAW IS LIMITED TO THE WARRANTY PERIOD.

Regardless of whether a claim against CAFP is based on the warranty or is an action in contract, tort (*negligence or strict liability*) or otherwise, CAFP's liability for losses, damages, or expenses of any kind arising from the design, manufacture, installation, use, repair, or sale of the flagpole is limited, unless otherwise prohibited by applicable law, to an amount not exceeding the cost of the CAFP flagpole giving rise to such liability. CAFP shall not be liable or responsible for any indirect, incidental, consequential or special damages.

Warranty Service

All warranty claims must be directed to:

CONCORD AMERICAN FLAGPOLE,
Customer Service Department, P.O. BOX 2449,
Addison, Texas 75001. Neither the flagpole nor the Accessory shall be returned without prior written authorization of CAFP and must be shipped freight prepaid by the Buyer. For further information, you may call CAFP Customer Service at 800-527-3902.

Legal Rights

Some states do not allow limitations on how long an implied warranty lasts or the exclusion or limitation of incidental or consequential damages, so the above limitations and exclusion may not apply to you. This warranty gives you specific legal rights and you may also have other rights which may vary from state to state.

CAFP's Right of Possession

CAFP shall have the right, in addition to all others it may possess, at any time, for credit reasons or because of Buyer's default or defaults, to withhold shipments, in whole or in part, and to recall goods in transit, retake same, and repossess all good which may be stored with CAFP for Buyer's account, without the necessity of taking any other proceedings, and Buyer consents that all the merchandise is so recalled, retaken or repossessed shall become CAFP's absolute property, provided that the Buyer is given full credit therefor. The foregoing shall not be construed as limiting, in any manner, any of the rights or remedies available to CAFP because of any default of Buyer under the Uniform Commercial Code as in force and effect in the Commonwealth of Virginia on the date of order of acceptance.

Controlling Provisions

These terms and conditions shall supersede any provisions, terms and conditions contained on any confirmation order, or other writing Buyer may give or receive, and the rights of the parties shall be governed exclusively by the provisions, terms and conditions hereof. CAFP makes no representations or warranties concerning any order except such as are expressly contained herein, and, these terms and conditions may not be changed or modified orally.

Purchase Order

If this quotation is accepted and Buyer's order form is used for the purpose, it is expressly understood and agreed that the terms and conditions herein set forth shall prevail insofar as the same may in any way conflict with the terms and conditions set forth in such order form, and the issuance of such order by Buyer shall be deemed to note Buyer's assent to the foregoing.

Payment Terms

Net amount of invoice is due and payable in full within thirty (30) days of invoice date. If in CAFP's opinion, the financial condition of the Buyer at any time does not justify continuance of production or shipment on the terms of payment specified, CAFP may require full or partial payment in advance of manufacture or shipment. Any indebtedness owing to CAFP for a period longer than thirty (30) days shall bear interest until paid at the current prime rate published in the Wall Street Journal. If CAFP finds it necessary to place any indebtedness hereunder in the hands of an attorney for collection, the Buyer shall pay all expenses and costs of collection, including reasonable attorney's fees.

Liability

CAFP shall not be liable for loss or damage of any kind resulting from delay or inability to deliver on account of fire, labor troubles, accident, acts of civil or military authorities, or from any other cause beyond CAFP's control.

Cancellation

An order once placed and accepted by CAFP can be canceled only with CAFP's consent and upon terms that will indemnify CAFP against loss.

Returned Material

In no case are goods to be returned without prior written consent. Only unused material as currently manufactured, which has been invoiced to Buyer within ninety (90) days, will be considered for return. Material accepted for credit is subject to a minimum service charge of twenty-five percent (25%) plus all transportation charges. Material built to order is not subject to return for credit under any circumstances. Goods must be securely packaged to reach CAFP without damage.

General

The provisions on the face hereof and these Terms and Conditions constitute the entire agreement among the parties and supersede the provisions of any purchase order, other communication between the parties or any statement or representation not included herein. This agreement may not be modified or amended except in a writing signed by the party intended to be bound thereby. This agreement shall be governed by the laws of the Commonwealth of Virginia.

Concord American Flagpole warrants its aluminum flagpole shafts for their **LIFETIME**.

By combining industry-leading manufacturing technologies with exceptional Engineering and Design, Concord American Flagpole provides the highest quality products available to the industry today. We truly believe in the longevity and durability of our aluminum flagpole assemblies, and are proud to offer the flagpole industry's first Lifetime Flagpole Shaft Warranty.

(Residential Flagpole Kits excluded.)

Concord American Flagpole Limited Warranty — Hardware and Accessories

In addition to the **Lifetime Flagpole Shaft Warranty**, Concord American Flagpole warrants hardware and accessories to be free from defects in material and workmanship for a period of one year from the date of shipment (*Flags and other exceptions noted*). This **Best-in-Class Warranty** is made possible through strict Vendor Certification guidelines and a dedication to superior Quality Control.

Visit www.ConcordAmericanFlagpole.com for complete Warranty information.



Limited Lifetime Warranty For Flagpoles

Concord American Flagpole ("CAFP") warrants to the first purchaser ("Buyer") of a CAFP flagpole shaft (the "Flagpole") that the Flagpole will, upon shipment by CAFP, be free from defects in material and workmanship and to be free from corrosion except those items normally consumed in service (the "Warranty"). The Warranty applies to the pole shaft only and excludes anchor bolts, flagpole accessories, foundations and finishes such as powder coating and anodizing. CAFP provides separate warranties for its anodized and powder coated finishes and for hardware and other Flagpole accessories. **WITH RESPECT TO FLAGS, CAFP MAKES NO, AND EXPRESSLY DISCLAIMS, ALL WARRANTIES.**

If any failure to conform to the Warranty appears, and written notice of such failure is given to CAFP during the lifetime of the Flagpole's intended use (the "Warranty Period"), CAFP will, upon substantiation of such nonconformity and at its sole option, either repair or replace the non-conforming Flagpole. Specifically excluded from the Warranty is the cost to remove, ship, replace, or reinstall the non-conforming or repaired/replaced Flagpole. Repair or replacement by CAFP is the Buyer's sole remedy, and CAFP's sole obligation, in the event of a failure to conform to the Warranty. The Warranty does not cover defects or failures resulting from improper maintenance, misuse, abuse, radiation, overloading, accident, acts of God, or other casualty beyond the control of CAFP; alterations, modification or additions without written permission from CAFP, or from failures or corrosion due to:

- Improper installation.
- Misapplication – product used outside of specified use.
- Damage from handling, transportation, installation, vehicular impact, abuse, or vandalism.
- Site specific wind induced or other vibration.
- Installation in soils with a pH under 5 or over 9.
- Installation using highly caustic grouts or concrete.
- Improper grounding.

All warranty claims must be directed to: **CONCORD AMERICAN FLAGPOLE**, Customer Service Department, P.O. BOX 2449, Addison, Texas 75001. The Flagpole shall not be returned without prior written authorization of CAFP and must be shipped freight prepaid by the Buyer. If CAFP elects to replace the nonconforming Flagpole, such replaced Flagpole shall become the property of CAFP.

CAFP MAKES NO OTHER EXPRESS WARRANTY AND EXPRESSLY DISCLAIMS ANY WARRANTY OF MERCHANTABILITY OR FITNESS FOR A PARTICULAR PURPOSE AND ALL OTHER IMPLIED WARRANTIES OTHER THAN THOSE THAT MAY NOT BE DISCLAIMED AS A MATTER OF LAW. THE DURATION OF ANY IMPLIED WARRANTY THAT MAY NOT BE DISCLAIMED BY APPLICABLE STATE OR FEDERAL LAW IS LIMITED TO THE WARRANTY PERIOD.

Regardless of whether a claim against CAFP is based on the Warranty or is an action in contract, tort (negligence or strict liability) or otherwise, CAFP's liability for losses, damages, or expenses of any kind arising from the design, manufacture, installation, use, repair, or sale of the flagpole is limited, unless otherwise prohibited by applicable law, to an amount not exceeding the cost of the CAFP flagpole giving rise to such liability. CAFP shall not be liable or responsible for any indirect, incidental, consequential or special damages.

Some states do not allow limitations on how long an implied warranty lasts or the exclusion or limitation of incidental or consequential damages, so the above limitations and exclusion may not apply to you. This warranty gives you specific legal rights and you may also have other rights which may vary from state-to-state.

This Warranty applies only to Concord American Flagpole aluminum pole assemblies shipped on or after January 1, 2018.

CONCORD AMERICAN FLAGPOLE
 Customer Service Department
 P.O. BOX 2449
 Addison, Texas 75001
 800-527-3902
 www.concordamericanflagpole.com



**Highest Quality
Standard Flagpole
Components**

**The Largest
Flagpole
and Flagpole
Component
Inventories**



**Concord American Flagpole's
products are sold exclusively
through the industry's most
qualified Flag and Banner
Dealers and Division 10
Sales Representatives.**



**PHONE: 800-527-3902
FAX: 800-426-5770**

**Corporate
Headquarters**
P.O. Box 2449
4150 Kellway Circle
Addison, TX 75001
Phone: 972-380-8186
Fax: 972-380-5143

Manufacturing and Shipping Locations:
4150 Kellway Circle • Addison, TX 75001
26252 Hillman Highway • Abingdon, VA 24210
1030 Lone Oak Rd • Eagan, MN 55121
www.ConcordAmericanFlagpole.com
email: info@ConcordAmericanFlagpole.com

CAFP-2019 (01-19) ©2019 CONCORD AMERICAN FLAGPOLE

